

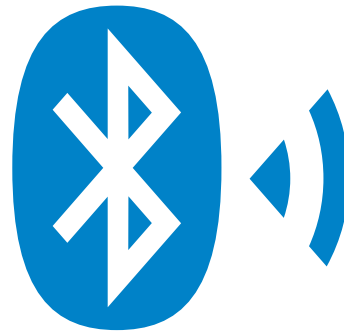

HAYWARD®

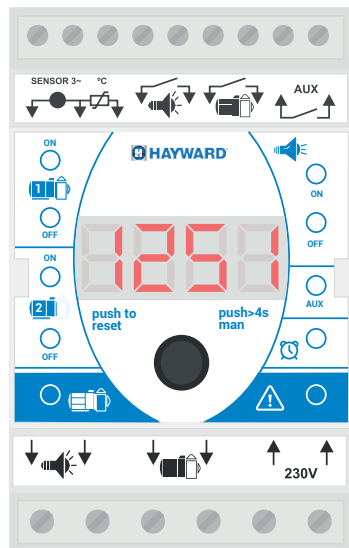

H-Power

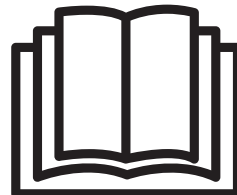
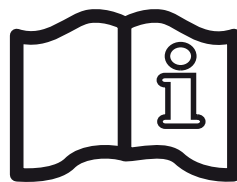

GUIDE DE L'UTILISATEUR
USER'S GUIDE
MANUAL DEL USUARIO
MANUAL DO UTILIZADOR
ANWENDERHANDBUCH
GEBRUIKERSHANDLEIDING
MANUALE D'USO
РУКОВОДСТВО ПО ЭКСПЛУАТАЦИИ

(FR) AVERTISSEMENTS DE SÉCURITÉ / (EN) WARNING / (ES) ADVERTENCIAS DE SEGURIDAD / (PT) ADVERTÊNCIAS DE SEGURANÇA / (DE) SICHERHEITSHINWEISE / (NL) VEILIGHEIDSWAARSCHUWINGEN / (IT) AVVERTENZE DI SICUREZZA / (RU) ПРЕДУПРЕЖДЕНИЯ О БЕЗОПАСНОСТИ 00

1. (FR) MODÈLES HPOW / (EN) HPOW MODELS / (ES) MODELOS HPOW / (PT) MODELOS HPOW / (DE) HPOW-MODELLE / (NL) HPOW-MODELLEN / (IT) MODELLI HPOW / (RU) МОДЕЛИ HPOW 01

2. (FR) RACCORDEMENTS / (EN) WIRING / (ES) CONEXIONAD / (PT) LIGAÇÃO / (DE) ANSCHLUSS / (NL) BEKABELING / (IT) CONNESSIONI / (RU) ПОДКЛЮЧЕНИЕ..... 02

FRANÇAIS (FR)

3. MODULE DE CONTRÔLE	04
4. MISE EN MARCHÉ	05
5. CONTRÔLE MANUEL DU FILTRAGE ET DE L'ÉCLAIRAGE	06
6. PROTECTION DE L'ÉPURATEUR	07

TEST D'AUTORÉGLAGE
SURCHARGE ET RESET
PROTECTION ANTIBLOCCAGE

7. ÉLÉMENTS ADDITIONNELS DE CONTRÔLE 08

FILTRAGE ON / OFF
ÉCLAIRAGE ON / OFF
CHANGEMENT COULEUR ÉCLAIRAGE
ARRÊT POUR REMPLISSAGE
CONTRÔLE DE TEMPÉRATURE
TÉLÉCOMMANDE OPTIONNELLE (UR1)
CONTACTAUXILIAIRE(AUX)

8. LECTURE DES DONNÉES	09
9. BLUETHOOTH	10
10.SPÉCIFICATIONS	11

ENGLISH (EN)

3. CONTROL MODULE	12
4. START-UP	13
5. MANUAL MODE	14
6. PUMP PROTECION	15

AUTOMATIC CALIBRATION OVERLOAD PROCEDURE
OVERLOAD AND RESET
JAMMED IMPELLER PROTECTION

7. EXTERNAL ON / OFF 16

FILTRATION ON/OFF
LIGHTING ON/OFF
LIGHTING COLOUR SHIFT
REFILLING AUTOMATIC STOP
TEMPERATURE CONTROL
REMOTE CONTROL VIA RADIO (OPTION UR1 MODULE)
AUXILIARY CONTACT (AUX LED)

8. PUMP OPERATION DATA DOWNLOAD	17
9. BLUETHOOTH	18
10. SPECIFITACIONS	19

ESPAÑOL (ES)

3. MÓDULO DE CONTROL	20
4. PUESTA EN MARCHA	21
5. CONTROL MANUAL DE FILTRADO E ILUMINACIÓN	22
6. PROTECCIÓN DE LA DEPURADORA	23

TEST DE AUTOCALIBRACIÓN
SOBRECARGA Y RESET
PROTECCIÓN ANTI-BLOQUEO

7. ELEMENTOS ADICIONALES DE CONTROL 24

FILTRADO ON / OFF
ILUMINACIÓN ON / OFF
CAMBIO DE COLOR DE LA ILUMINACIÓN
PARO POR RELLENADO
CONTROL DE TEMPERATURA
CONTROL REMOTO OPCIONAL (UR1)
CONTACTO AUXILIAR (AUX)

8. LECTURE DE DATOS	25
9. BLUETHOOTH	26
10. ESPECIFICACIONES	27

PORTUGUES (PT)

3. MÓDULO DE CONTROLO	28
4. INÍCIO DE FUNCIONAMENTO	29
5. CONTROLO MANUAL DE FILTRAÇÃO E ILUMINAÇÃO	30
6. PROTEÇÃO DA DEPURADORA	31

TESTE DE AUTO CALIBRAÇÃO
SOBRECARGA E RESET
PROTEÇÃO ANTIBLOQUEIO

7. ELEMENTOS ADICIONAIS DE CONTROLO..... 32

FILTRAÇÃO ON/OFF
ILUMINAÇÃO ON / OFF
MUDANÇA DE COR DA ILUMINAÇÃO
PARAGEM POR RECHEIO
CONTROLO DE TEMPERATURA
CONTROLO REMOTO OPCIONAL (UR1)
CONTACTO AUXILIAR(AUX)

8. LEITURA DE DATOS	33
9. BLUETHOOTH	34
10. ESPECIFICAÇÕES	35

DEUTSCH (DE)

3. STEUERMODUL	36
4. INBETRIEBNAHME	37
5. MANUELLE FILTER- UND BELEUCHTUNGSSTEUERUNG	38
6. SCHUTZ DER PUMPE	39
AUTOMATISCHER KALIBRATIONSTEST ÜBERLASTUNG UND RESET BLOCKIERSCHUTZ	

7. ZUSÄTZLICHE STEUERELEMENTE	40
FILTER EIN / AUS BELEUCHTUNG EIN / AUS ÄNDERUNG DER LICHTFARBE STILLSTAND WEGEN ÜBERFÜLLUNG TEMPERATURKONTROLLE OPTIONALE FERNSTEUERUNG (UR1) HILFSKONTAKT (AUX)	
8. DATENAUSLESUNG	41
9. BLUETHOOTH	42
10. SPEZIFIKATIONEN	43

NETHERLAND (NL)

3. BEDIENINGSMODULE	44
4. OPSTARTEN	45
5. HANDMATIGE BEDIENINGVAN FILTRATIEENVERLICHTING	46
6. BESCHERMING VAN DE ZUIVERINGSINSTALLATIE	47
ZELFIJKINGSTEST OVERBELASTINGEN RESET BESCHERMING DEBLOKKERING	

7. EXTRA BEDIENINGSELEMENTEN	48
FILTRATIEAAN/ UIT VERLICHTING AAN / UIT VERLICHTINGSKLEUR WIJZIGEN AUTOMATISCHE HERVULSTOP BEDIENING TEMPERATUUR OPTIONELE AFSTANDSBEDIENING(UR1) HULPCONTACT (AUX)	
8. HET LEZEN VAN GEGEVENS	49
9. BLUETHOOTH	50
10. SPECIFICATIES	51

ITALIANO (IT)

3. MODULO DI CONTROLLO	52
4. AVVIAMENTO	53
5. CONTROLLO MANUALE DI FILTRAGGIO E ILLUMINAZIONE	54
6. PROTEZIONE DELLA DEPURATRICE	55
TEST DE AUTOCALIBRAZIONE SOVRACCARICO E RESET PROTEZIONE ANTI-BLOCCO	

7. ELEMENTI AGGIUNTIVI DI CONTROLLO	56
FILTRAGGIO ON / OFF ILLUMINAZIONE ON / OFF CAMBIAMENTO DI COLORE DELL'ILLUMINAZIONE ARRESTO PER RIEMPIMENTO CONTROLLO TEMPERATURA TELECOMANDO OPTIONAL (UR1) CONTATTO AUSILIARE (AUX)	
8. LETTURA DI DATI	57
9. BLUETHOOTH	58
10. SPECIFICHE	59

РУССКИЙ (RU)

3. МОДУЛЬ УПРАВЛЕНИЯ	60
4. ЗАПУСК	61
5. РУЧНОЕ УПРАВЛЕНИЕ ФИЛЬТРОВАНИЕМ И ОСВЕЩЕНИЕМ ..	62
6. ЗАЩИТА ОЧИСТИТЕЛЬНОЙ УСТАНОВКИ	63
ТЕСТ НА АВТОКАЛИБРОВКУ ЧРЕЗМЕРНАЯ НАГРУЗКА И ПЕРЕЗАПУСК АНТИБЛОКИРОВОЧНАЯ ЗАЩИТА	

7. ДОПОЛНИТЕЛЬНЫЕ ЭЛЕМЕНТЫ УПРАВЛЕНИЯ	64
ФИЛЬТРОВАНИЕ: ВКЛ./ ВЫКЛ ОСВЕЩЕНИЕ: ВКЛ./ ВЫКЛ. ИЗМЕНЕНИЕ ЦВЕТА ОСВЕЩЕНИЯ ОСТАНОВКА ПРИ ЗАПОЛНЕНИИ УПРАВЛЕНИЕ ТЕМПЕРАТУРОЙ ОПЦИОНАЛЬНОЕ ДИСТАНЦИОННОЕ УПРАВЛЕНИЕ (UR1) КОНТАКТ ВСПОМОГАТЕЛЬНЫЙ (AUX)	
8. LEITURA DE DATOS	65
9. BLUETHOOTH	66
10. СПЕЦИФИКАЦИИ	67

FRANÇAIS (FR)

2.1 SYMBOLES DE SECURITE DANS LE MANUEL D'INSTRUCTIONS. Les instructions qui ont trait aux risques pour les personnes sont représentées au moyen des deux symboles suivants: Précaution pour danger en général ⚠ Norme DIN 4844-W9. Précaution pour danger de décharge électrique ⚠ Norme DIN 4844-W8. D'autres instructions en rapport avec le fonctionnement de l'équipement et dont le manque d'accomplissement peut l'abîmer physiquement, sont détachées avec l'inscription: **ATTENTION** **2.2 PLAQUES DE CARACTERISTIQUES (de la CEE 89/392 p.1.7.4.a).** Tout ce qui soit indiqué sur la plaque de caractéristiques ou d'autres instructions que le fabricant place sur l'unité doit être strictement suivi. Le contenu de ces plaques, normalement, sera compris dans ce manuel (Chapitre 1.2.). **2.3 RESPONSABILITE.** Le manque d'accomplissement des instructions indiquées par le fabricant dans ce Manuel, pour l'élection, utilisation, installation, mise en marche et entretien de l'unité, exonère le fabricant ou le distributeur de responsabilités par accidents possibles sur les personnes ou dommages sur le reste des installations, et entraînera, d'autre part, la perte de garantie. **2.4 NORMES.** (*)voir tableau **3. INSTRUCTIONS GENERALES CONCERNANT LA SECURITE DE L'UTILISATEUR.** **3.1** ⚠ La sécurité du fonctionnement de la machine fournie ne pourra être assurée que si son utilisation répond à ce qui est dit indiqué sur les figures de la page 45 "ILLUSTRATIONS". Les conditions et les limites de travail indiqués dans ce manuel ne devront jamais être dépassés (Chapitre 1.2 - Caractéristiques Techniques). Il est obligé de respecter les Normes de Sécurité en vigueur en chaque pays. **3.2** ⚠ Vérifier que l'équipement a été correctement sélectionné pour l'application à laquelle il sera destiné et que son état, installation, mise en marche et son ultérieur utilisation sont corrects. Voir chapitre 1.2 (Caractéristiques Techniques). **3.3** ⚠ Les opérations d'installation, réparation et entretien seront toujours réalisées avec l'équipement débranché du réseau d'alimentation électrique. **3.4** ⚠ Lors du fonctionnement de l'équipement il ne peut pas être déplacé ni sa position être corrigée. Ces opérations seront toujours réalisées avec la machine arrêtée. **3.5** ⚠ L'actionnement des éléments électriques de connexion-déconnexion ou sécurité ne peut pas avoir lieu en présence d'humidité, tout en faisant une spéciale attention à celle qui peut exister dans les mains de l'ouvrier, ses chaussures ou les surfaces de contact. **3.6** ⚠ Les éléments de l'équipement qui lors de leur fonctionnement sont en mouvement ou puissent atteindre des températures dangereuses seront protégés au moyen de petites grilles ou armatures qui empêchent le contact accidentel avec eux. **3.7** ⚠ Les conducteurs électriques, ou les parties qui peuvent être sous tension, auront un isolement approprié. D'autres parties métalliques de l'équipement seront solidement reccordées à terre. **3.8** ⚠ Les pièces de rechange seront les originaires du fabricant ou les préconisées par celui-ci. L'utilisation d'autres pièces ou de pièces originales rectifiées par des tiers n'est pas admise et exempte le fabricant ou le distributeur de leurs responsabilités. LE MATERIEL A BESOIN DE 48 HEURES D'ALIMENTATION MINIMUM.

ENGLISH (EN)

2.1 SAFETY SIGNS USED IN THE HANDBOOK. All instructions referring to possible risks to persons are highlighted by the following symbols: Danger in general. ⚠ Standard DIN4844-W9. Danger of electrocution ⚠ Standard DIN4844-W8 Other instructions in relation to the functioning of the equipment with which non-compliance could cause physical damages are highlighted with the warning: **ATTENTION** **2.2 NAMEPLATE RATINGS (EEC 89/392 P.1.7.4.A).** The information given on the nameplate or other instructions affixed by the manufacturer to the unit, must be strictly complied with. The content of these plates can usually be found in this Handbook (Chapter 1.2.). **2.3 LIABILITY.** Failure to comply with the instructions given by the manufacturer in this Handbook, in relation to the choice, handling, installation, starting and maintenance of the unit, shall release the manufacturer or distributor from all liability in respect of accidents suffered by persons or damages caused to other installations and, in addition, shall entail forfeit of the warranty. **2.4 STANDARDS.** (*) look table. **3. GENERAL INSTRUCTIONS IN RELATION TO USER SAFETY.** **3.1** ⚠ Safety during operation of the machinery supplied can only be guaranteed if it is used in accordance with the diagrams shown on page 45 "ILLUSTRATIONS". It must never exceed the working conditions and limits given in this Handbook (Chapter 1.2 - Technical Characteristics). Compliance with the provisions of Safety Standards in force in each country is mandatory. **3.2** ⚠ Please ensure that the equipment selected is adequate for the use for which it is intended and that its condition, installation, starting and subsequent use are correct. See chapter 1 (Technical Characteristics). **3.3** ⚠ Installation, repair and maintenance operations will be carried out in all cases with the equipment disconnected from the mains. **3.4** ⚠ While the equipment is functioning, it cannot be moved or repositioned. These operations will be carried out at all times with the machine disconnected. **3.5** ⚠ Pressing of the electrical on/off or safety elements will not be performed where there is damp, and special care must be taken for user's hands to be dry, and also with footwear and surfaces with which the user is in contact. **3.6** ⚠ Those elements of the equipment which, when functioning, are in movement or which could reach dangerous temperatures, will be protected with cages or casing which will prevent accidental contact with the same. **3.7** Electricity conductors, or parts which could carry current, will be suitably insulated. Other metal parts of the equipment will be correctly earthed. **3.8** ⚠ Spare parts that may be necessary will be originals from the manufacturer or those recommended by the manufacturer. The use of others, or originals rectified by others, are not permitted and release the manufacturer or distributor from all liability. THE EQUIPMENT NEEDS 48 HOURS OF MINIMUM FEED

ESPAÑOL (ES)

2.1 SIGNOS DE SEGURIDAD EN EL MANUAL DE INSTRUCCIONES. Aquellas instrucciones que se refieren a los riesgos para las personas, se destacan con los dos símbolos siguientes: . Precaución por peligro en general ⚠ Norma DIN4844-W8 Norma. Precaución por peligro de descarga eléctrica ⚠ DIN 4844-W9 .Otras instrucciones que estén relacionadas con el funcionamiento del equipo y cuya falta de cumplimiento pueda dañarlo físicamente, se destacan con la inscripción: **ATTENTION** **2.2 PLACAS DE CARACTERÍSTICAS (de CEE 89/392 p.1.7.4.a).** Lo que se indique en la placa de características u otras instrucciones que el fabricante coloque sobre la unidad, se observarán en este Manual (Capítulo 1.2.). **2.3 RESPONSABILIDAD.** El no cumplimiento de las instrucciones dadas por el fabricante en este Manual, para la elección, manejo, instalación, puesta en marcha y mantenimiento de la unidad, libera al fabricante o distribuidor de responsabilidades por accidentes posibles a las personas o daños causados al resto de las instalaciones, ocasionando, además, la pérdida de la garantía. **2.4 NORMAS.** (*) mirar tabla. **3. INSTRUCCIONES GENERALES RELATIVAS A SEGURIDAD DEL USUARIO.** **3.1** ⚠ Sólo se podrá garantizar la seguridad del servicio de la máquina suministrada si su uso corresponde a lo indicado en los esquemas de la página 2 "ILUSTRACIONES". Nunca se deberán sobrepasar las condiciones y límites de trabajo indicados en este manual (capítulo 1.2 - Características Técnicas), así como las propias de la tarjeta de características eléctricas

indicadas en la bomba. Es obligatorio cumplir con lo legislado por las Normas de Seguridad vigentes en cada país. 3.2 ⚠ Asegurarse que el equipo se ha seleccionado adecuadamente a la aplicación a la que va destinado y que su estado, instalación, puesta en marcha y posterior uso sean correctos. Ver capítulo 1 (Características Técnicas). 3.3 ⚠ Las operaciones de instalación, reparación y mantenimiento se harán siempre con el equipo desconectado de la red de alimentación eléctrica. 3.4 ⚠ Mientras el equipo esté en funcionamiento no puede ser desplazado, ni corregida su posición. Estas operaciones se harán siempre a máquina parada. 3.5 ⚠ El accionamiento de los elementos eléctricos de conexión-desconexión o seguridad no puede hacerse con presencia de humedad, poniendo especial cuidado en la que pueda existir en las manos del operario, en su calzado o superficies de contacto. 3.6 ⚠ Los elementos del equipo que durante su funcionamiento estén en movimiento o puedan alcanzar temperaturas peligrosas, se protegerán con rejillas o carcasas que impidan el contacto accidental con ellos. 3.7 ⚠ Los conductores eléctricos, o partes que puedan estar bajo tensión, dispondrán del aislamiento adecuado. Otras partes metálicas del equipo se unirán solidariamente a tierra. 3.8 ⚠ Los repuestos necesarios serán los originales del fabricante o los recomendados por él. El uso de otros, o de originales rectificadas por terceros no están permitidos y eximen al fabricante o distribuidor de sus responsabilidades. EL EQUIPO NECESITA 48 HORAS DE ALIMENTACIÓN MÍNIMA.

PORTUGUES (PT)

2.1 SIGNOS DE SEGURANÇA NO MANUAL DE INSTRUÇÕES. Aquelas instruções que dizem respeito aos riscos para as pessoas, são destacadas com os dois símbolos seguintes: . Precaução por perigo em geral ⚠ Norma DIN4844-W8 ⚠ Norma. Precaução por perigo descarga elétrica DIN 4844-W9 Outras instruções que estejam relacionadas com o funcionamento do equipamento e cuja falta de cumprimento possa danificá-lo são destacadas com a inscrição: **ATTENTION** 2.2 PLACAS DE CARACTERÍSTICAS (de CEE 89/392 p.1.7.4.a). O que se indique na placa de características ou outras instruções que o fabricante coloque sobre a unidade, serão observadas neste Manual (Capítulo 1.2.). 2.3 RESPONSABILIDADE. O não cumprimento das instruções dadas pelo fabricante neste Manual, para a escolha, utilização, instalação, início de funcionamento e manutenção da unidade, exime o fabricante ou distribuidor de responsabilidades por acidentes possíveis às pessoas ou danos causados ao resto das instalações, ocasionando, ainda, a perda da garantia. 2.4 NORMAS. (*) ver tabela. 3. INSTRUÇÕES GERAIS RELATIVAS À SEGURANÇA DO UTILIZADOR. 3.1 ⚠ Apenas pode ser garantida a segurança do serviço da máquina fornecida se a sua utilização corresponder ao indicado nos esquemas da página 2 "ILUSTRAÇÕES". Nunca se devem ultrapassar as condições e limites de trabalho indicados neste manual (capítulo 1.2 - Características Técnicas), bem como as próprias do cartão de características elétricas indicadas na bomba. É obrigatório cumprir com o legislado pelas Normas de Segurança vigentes em cada país. 3.2 ⚠ Assegurar-se que o equipamento foi selecionado adequadamente à aplicação a que é destinado e que o seu estado, instalação, início de funcionamento e posterior uso sejam corretos. Ver capítulo 1 (Características Técnicas). 3.3 ⚠ As operações de instalação, reparação e manutenção devem fazer-se sempre com o equipamento desligado da rede de alimentação elétrica. 3.4 ⚠ Quando o equipamento estiver em funcionamento, não pode ser deslocado, nem corrigida a sua posição. Estas operações devem ser realizadas sempre com a máquina parada. 3.5 ⚠ O acionamento dos elementos elétricos de ligação-desligação ou segurança não se pode fazer com presença de humidade, dando especial atenção àquela que possa haver nas mãos do operário, no seu calçado ou nas superfícies de contacto. 3.6 ⚠ Os elementos do equipamento que durante o seu funcionamento estejam em movimento ou possam alcançar temperaturas perigosas, serão protegidos com grelhas ou carcaças que impeçam o contacto accidental com eles. 3.7 ⚠ Os condutores elétricos, ou partes que possam estar sob tensão, irão dispor do isolamento adequado. Outras partes metálicas do equipamento devem unir-se solidariamente à terra. 3.8 ⚠ As reposições necessárias serão as originais do fabricante ou as recomendadas por ele. O uso de outras, ou de originais retificados por terceiros não estão permitidos e eximem o fabricante ou distribuidor das suas responsabilidades. O EQUIPAMENTO PRECISA DE 48 HORAS DE ALIMENTAÇÃO MÍNIMA.

DEUTSCH (DE)

2.1 DIE SICHERHEITSSYMBOLS DIESES HANDBUCHES. Anweisungen, die auf Risiken für den Menschen hinweisen sollen, werden durch die folgenden Symbole hervorgehoben: Allgemeine Vorsicht ⚠ DIN 4844-W9. Vorsicht vor elektrischem Schlag ⚠ DIN 4844-W8. Andere Anweisungen in Verbindung mit dem Betrieb der Anlage, deren Nichtbefolgung einen physikalischen Schaden an der Anlage verursachen könnten, sind mit folgendem Hinweis: **ATTENTION** 2.2 TYPENSCHILDER (CE 89/392 p.1.7.4.a). Die Angaben des Typenschildes oder anderer Anweisungen, die vom Hersteller auf der Einheit angebracht werden, sind zu beachten. Die Aufschriften dieser Schilder werden in diesem Handbuch (Kapitel 1.2.) wiedergegeben. 2.3 HAFTUNG. Die Nichtbefolgung der vom Hersteller in diesem Handbuch gegebenen Anweisungen für die Auswahl, die Handhabung, die Installation, die Inbetriebnahme und die Wartung der Einheit, befreit den Hersteller oder Lieferanten von seiner Haftung bei möglichen Unfällen von Personen oder an der übrigen Installation verursachten Schäden, und führt außerdem zum Verlust der Garantie. 2.4 NORMEN. (*) siehe Tabelle 3. ALLGEMEINE, DIE SICHERHEIT DES ANWENDERS BETREFFENDE, ANWEISUNGEN 3.1 ⚠ Die Betriebssicherheit der gelieferten Maschinen kann nur garantiert werden, wenn der Gebrauch den Angaben der Schemen der Seite 45 "ABBILDUNGEN" entspricht. Niemals dürfen die in diesem Handbuch (Kapitel 1.2. Technische Daten) angegebenen Arbeitsbedingungen und Arbeitsgrenzen überschritten werden. Die vorgeschriebenen gültigen Sicherheitsnormen jedes Landes sind obligatorischer Weise zu erfüllen. 3.2 ⚠ Es ist sicherzustellen, dass die Anlage entsprechend der vorgesehenen Anwendung ausgewählt wurde und dass ihr Zustand, ihre Installation, Inbetriebnahme und nachfolgender Gebrauch einwandfrei sind. Siehe Kapitel 1 (Technische Daten). 3.3 ⚠ Alle Arbeitsschritte bei der Installation, der Reparatur und der Wartung haben immer am vom elektrischen Versorgungsnetz getrennten Gerät zu erfolgen. 3.4 ⚠ Während das Gerät in Betrieb ist, darf es weder verschoben noch in seiner Lage korrigiert werden. Diese Arbeitsschritte müssen immer bei stillstehender Maschine erfolgen. 3.5 ⚠ Die Betätigung der elektrischen Ein- / Ausschaltender der Sicherheitselemente darf nicht bei Vorhandensein von Feuchtigkeit erfolgen. Insbesondere ist auf die Feuchte zu achten, die möglicherweise an den Händen des Bedieners, an seinen Schuhen oder den Kontaktflächen vorhanden sein kann. 3.6 ⚠ Die Elemente der Anlage, die während des Betriebes in Bewegung sind, oder aber hohe Temperaturen erreichen, sind mit Gittern oder Gehäusen geschützt, um so einen unbeabsichtigten Kontakt mit ihnen zu vermeiden. 3.7 ⚠ Die elektrischen Leiter oder Teile, die unter Spannung stehen können, sind mit einer entsprechenden Isolierung versehen. Andere Metallteile der Anlage sind gemeinsam zu erden. 3.8 ⚠ Die benötigten Ersatzteile müssen Originalteile des Herstellers oder von ihm empfohlene Ersatzteile sein. Die Verwendung anderer Ersatzteile oder die Verwendung von Originalteilen, die von Dritten nachgearbeitet wurden, ist verboten und entbinden den Hersteller oder Vertreter von seiner Haftung. DIE AUSRÜSTUNG BENÖTIGT 48 STUNDEN MINDESTFUTTERMITTEL.

ITALIANO (IT)

2.1 **SEGNALI DI SICUREZZA NEL MANUALE D'ISTRUZIONI.** Le istruzioni che si riferiscono a possibili rischi per le persone vengono indicate con i seguenti due segnali: Pericolo generico Norma ⚠ DIN 4844-W9 Pericolo scariche elettriche ⚠ Norma DIN 4844-W8. Ulteriori istruzioni relative al funzionamento dell'apparecchio, che, se non osservate, possono danneggiarlo fisicamente, vengono indicate con la scritta: **ATTENTION**

2.2 **TARGHETTA CARATTERISTICHE** (CEE 89/392 p.1.7.4.a). Quanto indicato nella targhetta caratteristiche, o qualsiasi altra istruzione posta dal fabbricante sull'elettropompa, va osservato scrupolosamente. Il contenuto di tali targhette viene riportato nel presente manuale al Capitolo 1.2.

2.3 **RESPONSABILITÀ.** La mancata osservanza delle istruzioni fornite dal fabbricante nel presente manuale per quanto riguarda la scelta, la manipolazione, l'installazione, la messa in servizio e la manutenzione dell'elettropompa, libera il fabbricante o distributore da qualsiasi responsabilità per possibili incidenti a persone o danni causati al resto delle installazioni, comportando così la perdita della garanzia.

2.4 **NORME.** (*) **Vedi tabella.**

3. **ISTRUZIONI GENERALI RELATIVE ALLA SICUREZZA DELL'UTENTE**

3.1 ⚠ La sicurezza del servizio fornito dall'elettropompa viene garantita solo se il suo utilizzo corrisponde a quanto indicato negli schemi a pagina 45 "ILLUSTRAZIONI". Non si devono mai superare le condizioni e limiti indicati nel presente manuale (capitolo 1.2. Caratteristiche Tecniche). È obbligatorio rispettare quanto previsto dalle Norme di Sicurezza vigenti in ciascun paese.

3.2 ⚠ Assicurarsi che la scelta dell'apparecchio sia adeguata all'applicazione prevista, nonché che le condizioni, l'installazione, la messa in servizio e il successivo utilizzo siano corretti. (Vedere Capitolo Caratteristiche Tecniche).

3.3 ⚠ Le operazioni di installazione, riparazione e manutenzione si dovranno sempre eseguire con l'apparecchio staccato dalla rete di alimentazione elettrica.

3.4 ⚠ Durante il funzionamento, l'apparecchio non a spostato, né si può modificarne la posizione. Tutte le operazioni andranno sempre eseguite a macchina ferma.

3.5 ⚠ L'azionamento degli elementi elettrici di collegamento-scollegamento o di sicurezza non può avvenire in presenza di umidità; sarà dunque necessario fare particolarmente attenzione alle mani dell'operatore, alle calzature che porta o alle superfici di contatto.

3.6 ⚠ Gli elementi dell'apparecchio che durante il funzionamento sono in movimento o possono raggiungere temperature pericolose andranno protetti con apposite reti che impediscano qualsiasi contatto accidentale.

3.7 ⚠ I conduttori elettrici e le parti sotto tensione dovranno essere provvisti di adeguato isolamento. Le restanti parti metalliche dell'apparecchio andranno collegate a terra.

3.8 ⚠ I ricambi dovranno essere necessariamente quelli originali del fabbricante, o quelli da lui consigliati. L'utilizzo di altri, o di originali modificati, non viene permesso e libera il fabbricante o distributore dalle sue responsabilità.

L'ATTREZZATURA HA BISOGNO DI 48 ORE DI ALIMENTAZIONE MINIMA.

NETHERLAND (NL)

2.1 **VEILIGHEIDSSIGNALLEN IN DE INSTRUCTIEHANDLEIDING.** Alle instructies die wijzen op eventuele risico's voor personen worden aangeduid met de volgende twee symbolen: Voorzichtigheid geboden bij algemeen gevaar Norm DIN4844-W8 Norm. Voorzichtigheid geboden wegens elektrische ontlading. DIN 4844-W9. Overige instructies die betrekking hebben op de werking van de apparatuur die door niet-naleving ervan aanzienlijk lichamelijk letsel kunnen veroorzaken, worden eveneens uitgelicht in de waarschuwing. : **OPGELET** **ATTENTION**

2.2 **NAAMPLATEN** (CEE 89/392 p.1.7.4.a). Hetgeen wordt aangegeven op de naamplaten of andere instructies hierop aangegeven, worden in deze handleiding uiteengezet (Hoofdstuk 1.2.).

2.3 **AANSPRAKELIJKHEID.** De niet-naleving van de door de fabrikant opgegeven instructies in deze handleiding, voor de keuze, de hantering, installatie, het opstarten en het onderhoud van de apparatuur, ontheft de fabrikant of distributeur van aansprakelijkheid voor eventuele letsels aan personen of aangerichte schade aan installaties, waarbij bovendien de garantie zal komen te vervallen.

2.4 **NORMEN.** (*) **ZIE TABEL.**

3. **ALGEMENE INSTRUCTIES BETREFFENDE DE VEILIGHEID VAN DE GEBRUIKER.**

3.1 ⚠ De veiligheid bij het gebruik van de aangeleverde machine wordt slechts gegarandeerd indien het gebruik overeenkomt met de aanwijzingen in de schematische illustraties op pagina 2 "ILLUSTRATIES". De in de handleiding aangegeven randvoorwaarden en werkbeperkingen mogen nooit worden overschreden (hoofdstuk 1.2 – Technische eigenschappen), alsmede die vermeld staan op de plaat met de elektrische eigenschappen van de pomp. De naleving van de landelijk geldende wettelijke veiligheidsvoorschriften is verplicht gesteld.

3.2 ⚠ U dient ervoor te zorgen dat de apparatuur alleen wordt ingezet voor de toepassing waarvoor deze is bestemd, deze in goede staat verkeert en de installatie, het opstarten en het daaropvolgend gebruik correct worden uitgevoerd. Zie hoofdstuk 1 (Technische eigenschappen).

3.3 ⚠ De handelingen betreffende de installatie, reparatie en onderhoud moeten altijd worden uitgevoerd met ontkoppelde stroomtoevoer.

3.4 ⚠ Zolang de apparatuur in werking is, kan deze niet worden verplaatst of qua positie bijgesteld. Deze handelingen moeten altijd bij stopgezette machine worden uitgevoerd.

3.5 ⚠ De machine kan niet worden aangezet met stekkers of veiligheidsknoppen in de aanwezigheid van vocht, waarbij vocht aan de handen en schoenen van de operator of de contactoppervlakken absoluut moet worden vermeden.

3.6 ⚠ De onderdelen van de apparatuur die tijdens werking in beweging zijn of gevaarlijk heet kunnen zijn, worden beschermd door middel van roosters of behuizingen waardoor deze oppervlakken buiten contactbereik blijven.

3.7 ⚠ Stroomgeleidende oppervlakken of onderdelen die onder spanning kunnen staan zijn voorzien van adequate isolatie. Overige metalen onderdelen van de apparatuur zijn op solide wijze geaard.

3.8 ⚠ De nodige reserveonderdelen dienen afkomstig van de fabrikant of door deze aanbevolen te zijn. Het gebruik van overige of van door derden bijgestelde originele reserveonderdelen is niet toegestaan en ontheft de fabrikant of distributeur van elke vorm van aansprakelijkheid. **DE APPARATUUR HEEFT 48 UUR MINIMUM VOEDING NODIG.**

РУССКИЙ (RU)

2.1 **СИМВОЛЫ БЕЗОПАСНОСТИ В РУКОВОДСТВЕ ПО ЭКСПЛУАТАЦИИ.** Данное руководство содержит следующие символы, связанные с риском для безопасности людей: Предупреждение об общей опасности ⚠ Норма DIN 4844-W9. Предупреждение о риске электрического разряда ⚠ Норма DIN4844-W9. Другие инструкции, связанные с работой оборудования, несоблюдение которых может привести к физическим травмам, отмечены знаком. **ATTENTION**

2.2 **ТАБЛИЧКИ ПАРАМЕТРОВ** (CEE 89/392 п.1.7.4.a). Данное руководство содержит все инструкции и характеристики, указанные на табличке параметров, комплектующей агрегат (раздел 1.2).

2.3 **ОТВЕТСТВЕННОСТЬ.** Невыполнение инструкций по выбору, перевозке, установке, вводу в эксплуатацию и техобслуживанию оборудования, изложенных производителем в данном руководстве, освобождает производителя или дистрибьютора от ответственности за возможные несчастные случаи с людьми и за материальный ущерб, нанесённый остальному оборудованию, а также снимает с него гарантийные обязательства.

2.4 **НОРМА ТИВЫ.** (*) **См.таблицу.**





3. **ОБЩИЕ ИНСТРУКЦИИ, СВЯЗАННЫЕ С БЕЗОПАСНОСТЬЮ ПОЛЬЗОВАТЕЛЯ**

3.1 ⚠️ Безопасная работа поставленного оборудования может быть гарантирована только в том случае, если его эксплуатация осуществляется в полном соответствии со схемами, приведёнными на стр. 45 «ИЛЛЮСТРАЦИИ». Запрещается превышать максимальные значения и рабочие параметры, содержащиеся в данном руководстве (раздел 1.2 – Технические характеристики), а также показатели, указанные на табличке электрических параметров насоса. Необходимо строго соблюдать все нормы техники безопасности, существующие в каждой стране. 3.2 ⚠️ Убедитесь в том, что оборудование приобретается с целью осуществления свойственных ему функций и в том, что последующее содержание, установка, запуск и эксплуатация агрегата полностью соответствует его конструкторским особенностям. См. раздел 1 (Технические Характеристики). 3.3 ⚠️ Для проведения любых операций по установке, ремонту и техобслуживанию необходимо отключить оборудование от источника питания. 3.4 Запрещается передвигать работающее оборудование или менять его положение. Для осуществления этих действий необходимо остановить агрегат. 3.5 ⚠️ При работе с электрическими подсоединениями и защитными элементами оборудования необходимо следить за отсутствием влаги, в особенности на руках и обуви пользователя, а также на контактных поверхностях. 3.6 ⚠️ Те элементы оборудования, которые в процессе работы приходят в движение или достигают опасных температур, ограждаются решётками или каркасами во избежание случайного контакта с ними. 3.7 ⚠️ Электрические проводники и компоненты, находящиеся под напряжением, снабжаются соответствующей изоляцией. Другие металлические части оборудования обладают общим заземлением. 3.8 ⚠️ При замене элементов оборудования необходимо использовать производителя или рекомендованные им компоненты. Использование не оригинальных запчастей или модификация оригинальных запчастей посторонними лицами не разрешается. Несоблюдение этого требования освобождает производителя или дистрибьютора от ответственности. **ОБОРУДОВАНИЮ НУЖНО 48 ЧАСОВ МИНИМАЛЬНОГО КОРМЛЕНИЯ.**

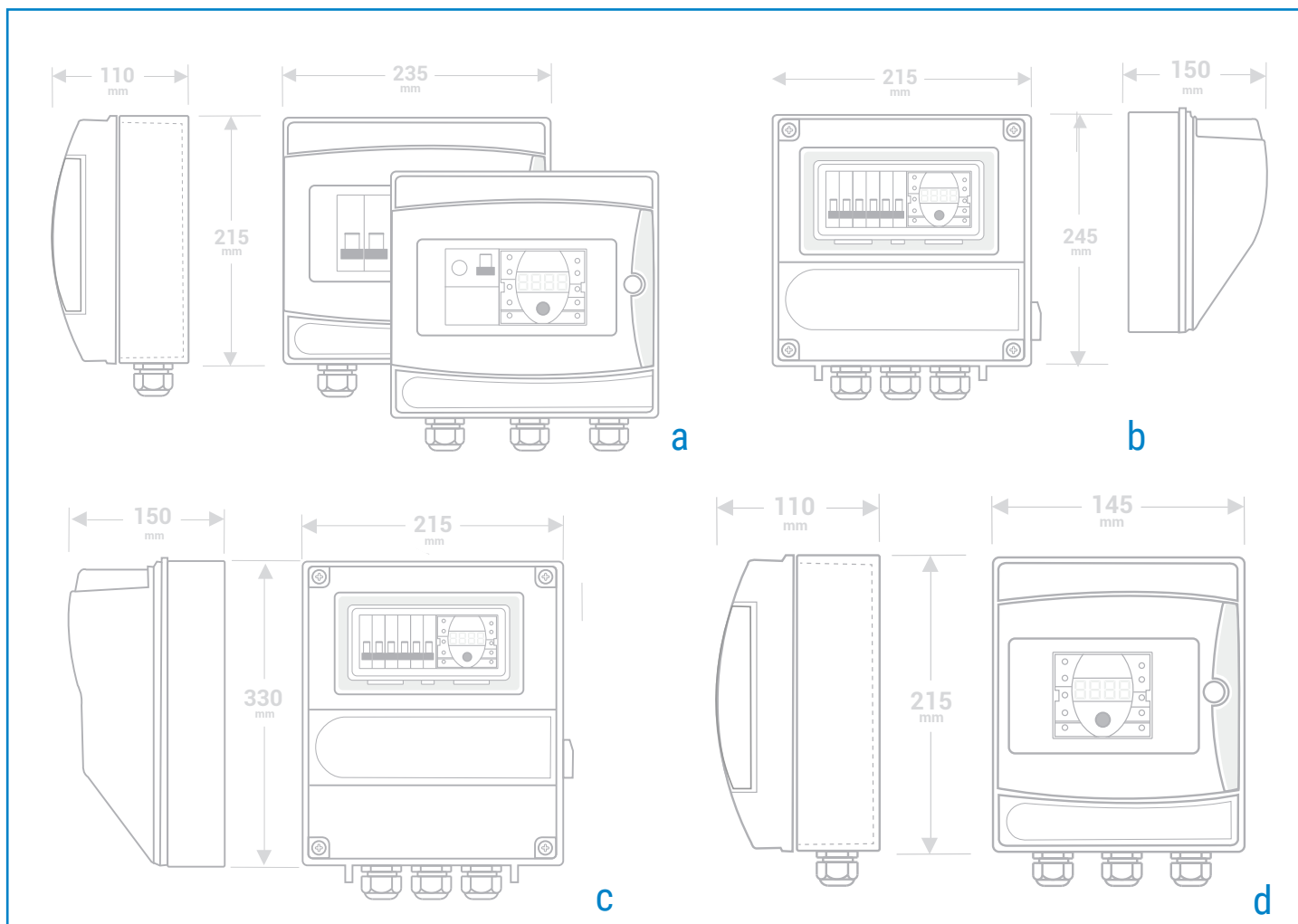

(*) FRANÇAIS (FR) **ATTENTION** **2.4 NORMES.** ⚠️ Les électropompes de piscines de notre marque sont fabriquées conformément aux conditions essentielles de sécurité et santé établies par les Directives communautaires. **ENGLISH (EN)** **ATTENTION** **2.4 STANDARDS.** ⚠️ Our swimming pool electropumps are manufactured in accordance with the necessary requirements for safety and health set forth in Community Directives. **ESPAÑOL (ES)** **ATTENTION** **2.4 NORMAS.** ⚠️ Las electrobombas de nuestra marca están fabricadas de acuerdo con los requisitos esenciales de seguridad y salud establecidas en las Directivas Comunitarias. **PORTUGUES (PT)** **ATTENTION** **2.4 NORMAS.** ⚠️ As eletrobombas da nossa marca estão fabricadas de acordo com os requisitos essenciais de segurança e saúde estabelecidas nas Diretivas Comunitárias. **DEUTSCH (DE)** **ATTENTION** **2.4 NORMEN.** ⚠️ Die Schwimmbad-Elektropumpen unserer Marke wurden in Übereinstimmung mit den grundlegenden, in den EG Richtlinien. **NETHERLAND (NL)** **LET OP!** **2.4 NORMEN.** ⚠️ De elektropompen voor zwembaden van ons merk zijn gefabriceerd in overeenstemming met de geldende veiligheidsvoorschriften en de EU-richtlijnen. **ITALIANO (IT)** **ATTENTION** **2.4 NORME.** ⚠️ Le elettropompe per piscina di nostra produzione vengono fabbricate nel rispetto delle norme essenziali di sicurezza e salute stabilite dalle Direttive Comunitarie. **РУССКИЙ (RU)** **2.4 НОРМАТИВЫ.** ⚠️ Электронасосы нашей марки произведены в соответствии с базовыми требованиями безопасности и охраны здоровья, содержащимися в Директивах.

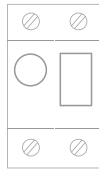
(*)	FR	
	EN	
	ES	EN 60335-1:2012 + AC:2014, EN 60335-2-41:2003 + A1:2004 + A2:2010, EN 62233:2008, Directive (2006/95/EC) – LVD, EN 55014-1:2006 + A1:2009 + A2:2011, EN 55014-2:1997 + AC:1997 + A1:2001 + A2:2008, EN 61000-3-2:2006 + A1:2009 + A2:2009, EN 61000-3-3:2013, Directive (2004/108/EC) – EMC
	PT	
	NL	
	IT	
	RU	
	DE	EN 60335-1:2012 + AC:2014, EN 60335-2-41:2003 + A1:2004 + A2:2010, EN 62233:2008, Directive (2006/95/EC) – LVD, EN 55014-1:2006 + A1:2009 + A2:2011, EN 55014-2:1997 + AC:1997 + A1:2001 + A2:2008, EN 61000-3-2:2006 + A1:2009 + A2:2009, EN 61000-3-3:2013, Directive (2004/108/ EC) – EMC festgeschrieben Voraussetzungen bezüglich Sicherheit und Gesundheit hergestellt.



PHASE	MODEL	SIZE	TRANSFORMER	OPTIONS
1 PH+N 	230 VAC HPOW -B-D	a	-	 -B BLUETOOTH  -D RESIDUAL CURRENT CIRCUIT BREAKER
		b	50W	
		b	100W	
		c	300W	
1 PH+N 	HPOWTPPOOL	d	-	

1 PH+N 	HPOWTPPOOL	d	-	
---	------------	---	---	--

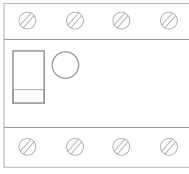
PHASE	MODEL	SIZE	TRANSFORMER	OPTIONS
3 PH+N 	400 VAC HPOW 400 -B-D	b	-	 -B BLUETOOTH  -D RESIDUAL CURRENT CIRCUIT BREAKER
		c	50W	
		c	100W	
		c	300W	

HPOW

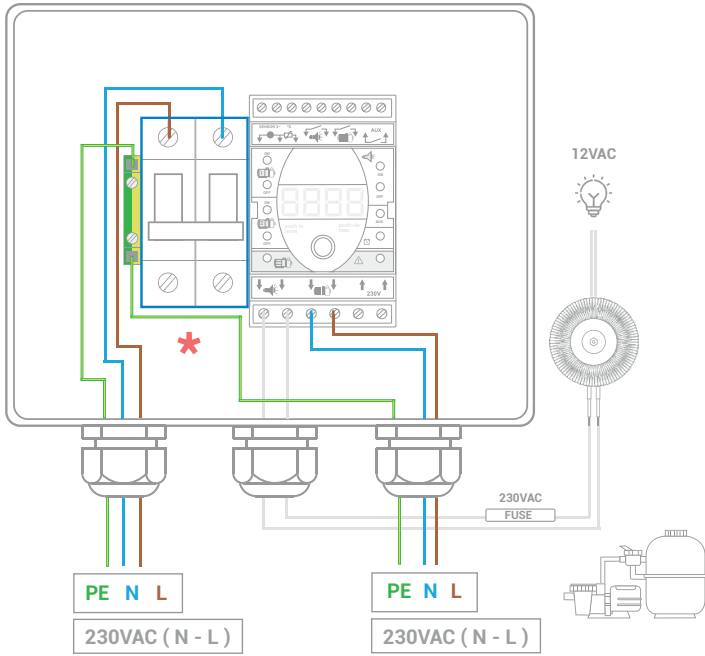

HPOW 50W / 100W

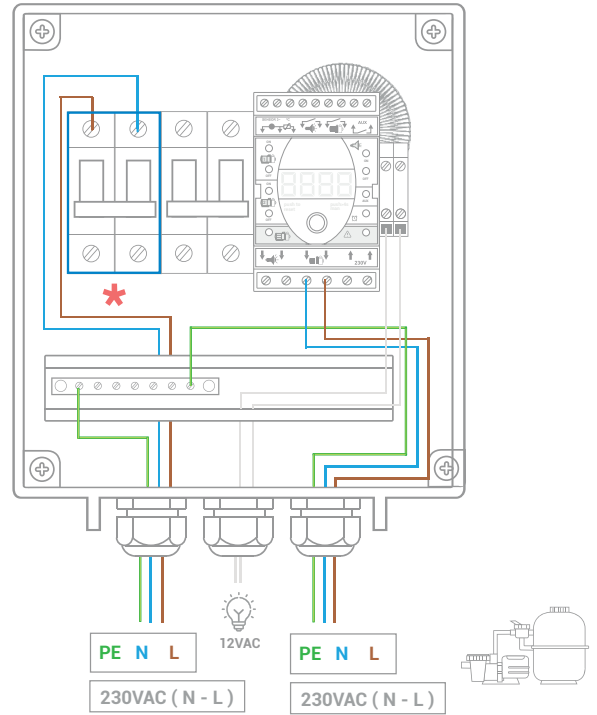

HPOW 300W

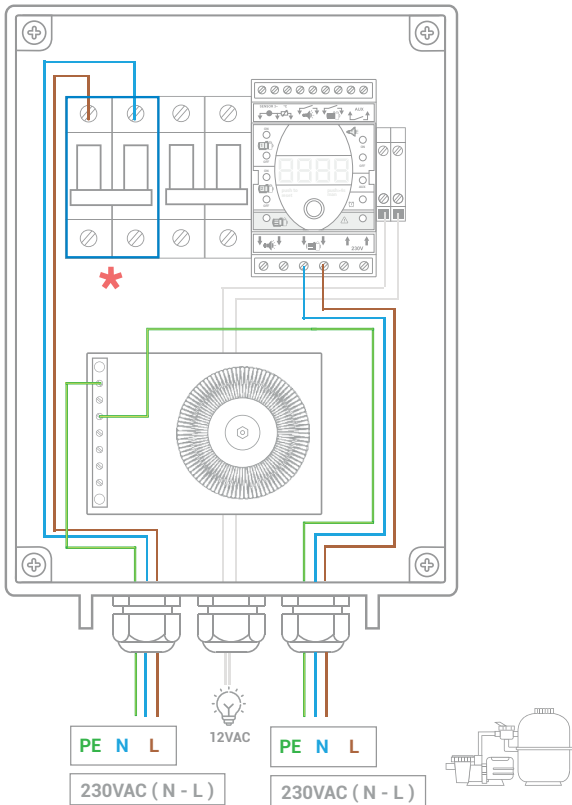

HPOWTPool

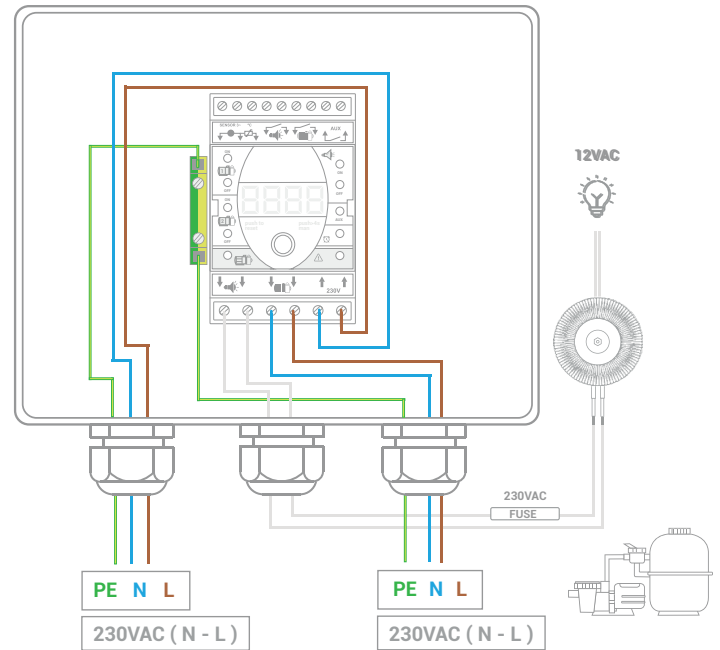

OPTIONS

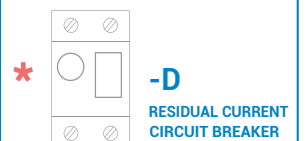

HPOW 400

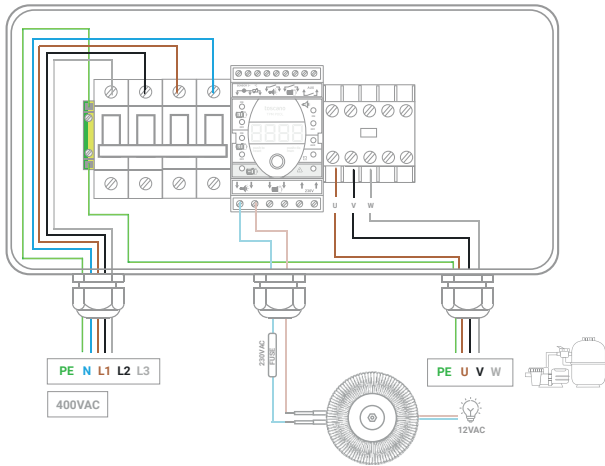

HPOW 400-T100/T300

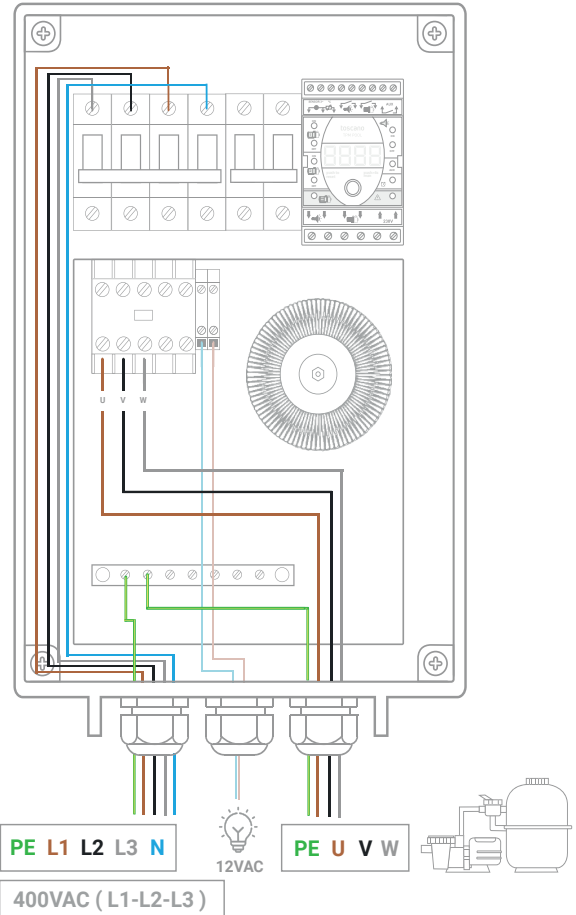

HPOW 400-D

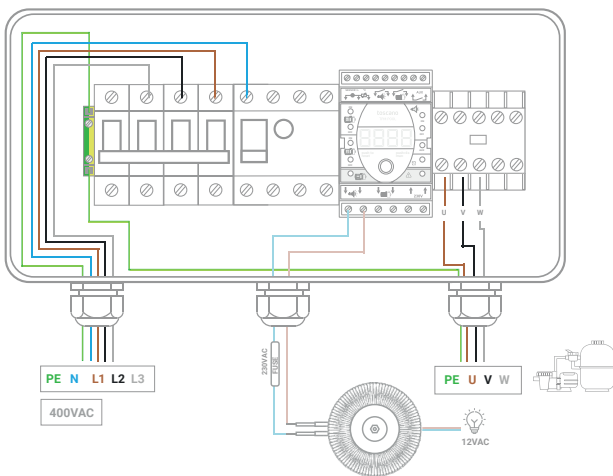

(FR) Les 4 vis et les 4 bouchons sont inclus.

(EN) The 4 screw and the 4 caps are included.

(ES) Los 4 tornillos y los 4 tapones están incluidos.

(PT) Os 4 parafusos e as 4 tampas estão incluídos.

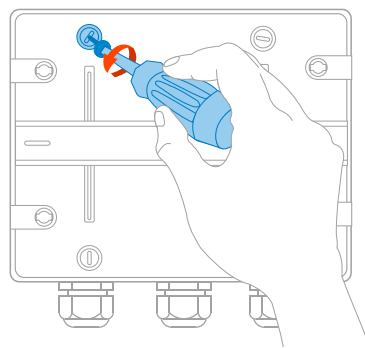

(DE) Die 4 Schrauben und die 4 Verschlusskappen sind enthalten.

(NL) De 4 schroeven en 4 doppen worden meegeleverd.

(IT) [Tappo] Le 4 viti e i 4 tappi sono inclusi.

(RU) 4 винта и 4 крышки включены в комплект.

3. Module de contrôle/Témoins

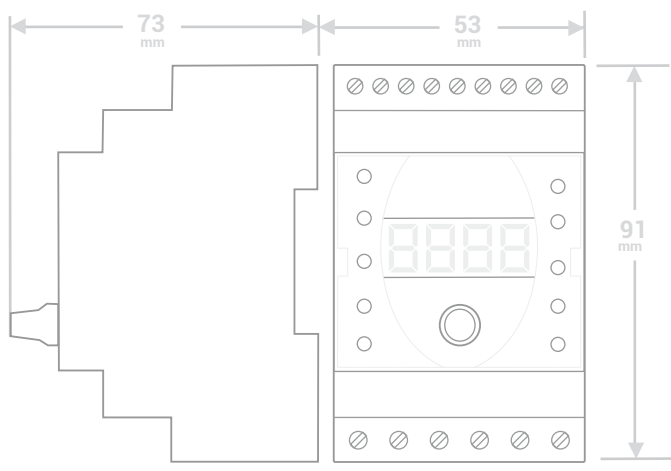
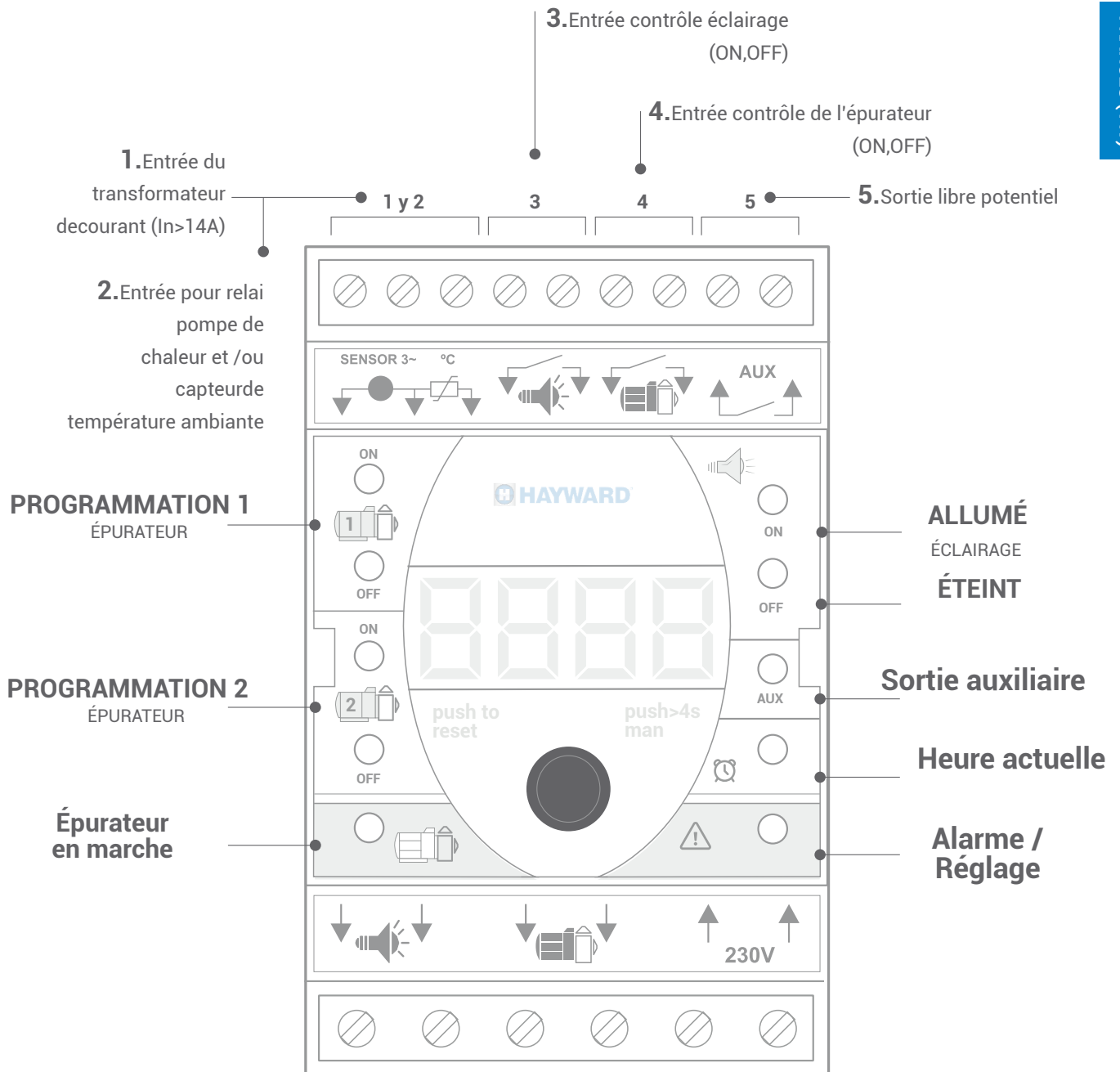

Les modèles avec Bluetooth se synchronisent automatiquement avec l'heure du Smartphone / Tablette

1. Réglage de l'heure actuelle

Sélectionner

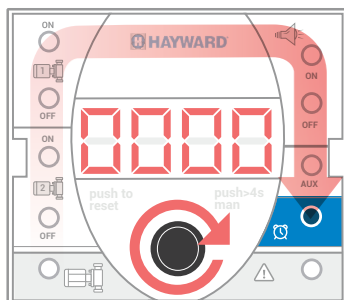

Pousser

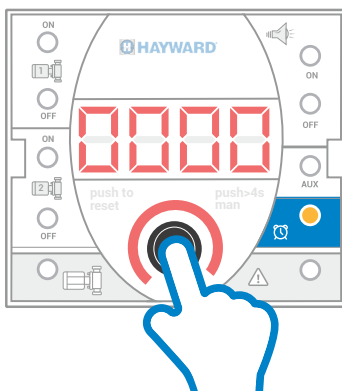

Modifiervaleur

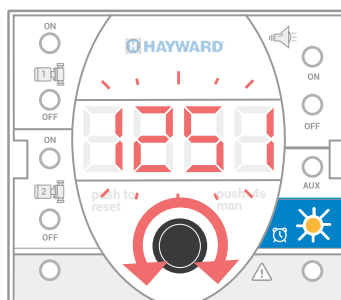

Confirmer

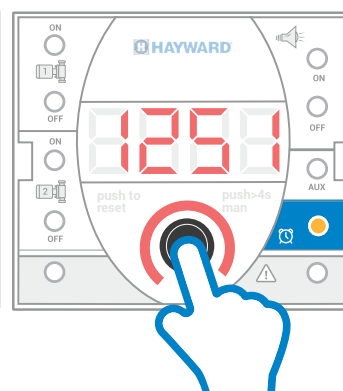

2. Programmes de filtrage et éclairage

ÉTAT DES LUMIÈRES

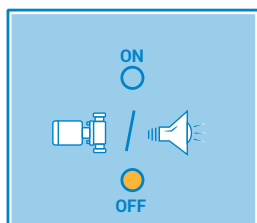
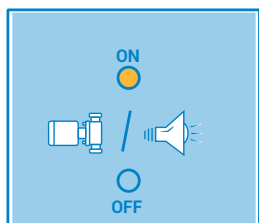

Pour annuler un programme sélectionner la même heure en ON et en OFF

Sélectionner



Pousser

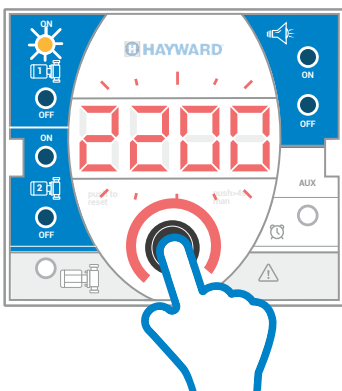

Modifiervaleur



Confirmer

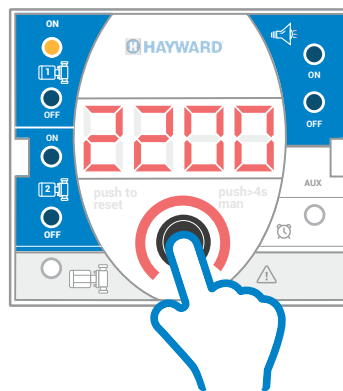

○ FONCTIONNEMENT / ARRÊT DU FILTRAGE

Maintenir poussé

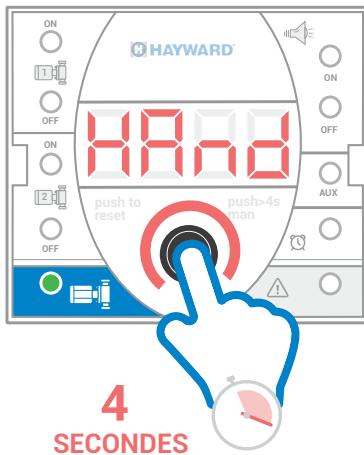

Pousser plus de 4 secondes pour mettre en marche l'épurateur.

Il s'éteindra à la fin du programme de filtrage suivant.

Pousser

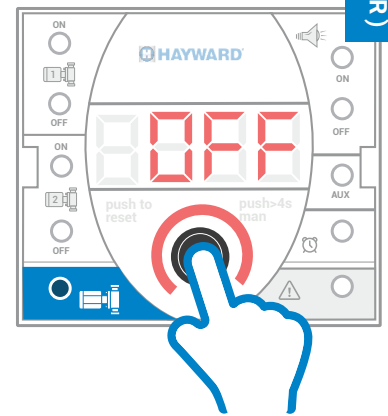

Pousser pour arrêter l'épurateur.

Il s'allumera au début du programme de filtrage suivant

○ ALLUMER / ÉTEINDRE LES PROJECTEURS

Maintenir poussé

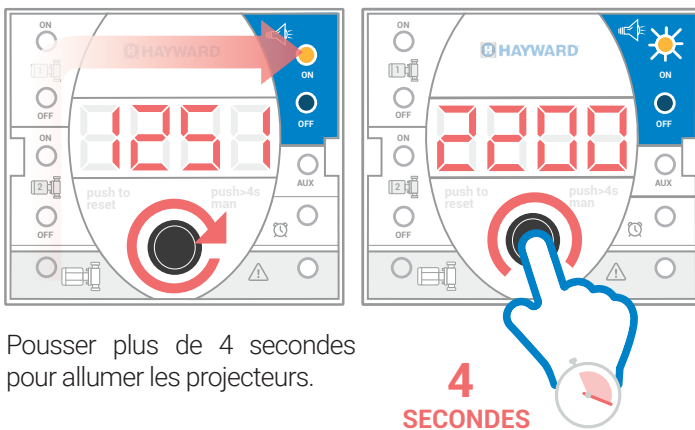

Pousser plus de 4 secondes pour allumer les projecteurs.

Ils s'éteignent automatiquement après 6 heures.

Maintenir poussé

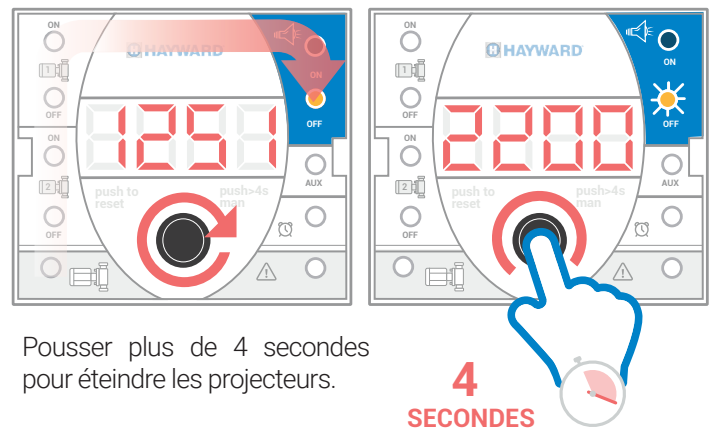

Pousser plus de 4 secondes pour éteindre les projecteurs.

Ils s'allument au début du programme d'éclairage suivant.

6. Protection épurateur

FRANÇÉS (FR)

○ Réglage de la protection de la pompe

Le dispositif se règle automatiquement lors de la 1ère. mise en marche. Pour tout nouveau réglage automatique, suivez les instructions suivantes.

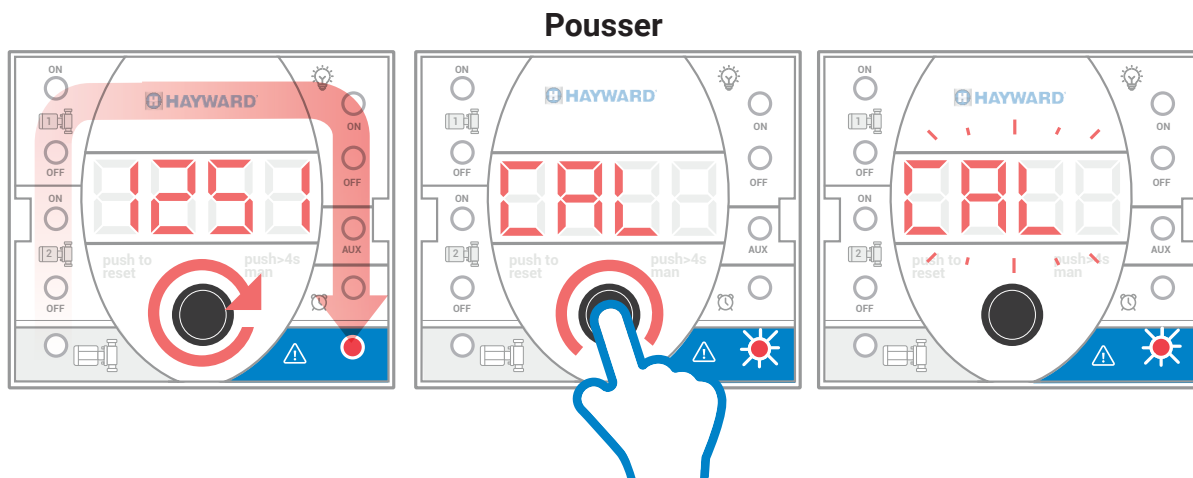

Une fois que la fonction "calibrage" a été activée, la pompe se règle automatiquement pendant les 8 premières minutes de fonctionnement.

○ Surcharge (overload) et reset

Causes possibles :

- Pompe non réglée.
- Pompe bloquée.

En cas de surcharge
le dispositif réalise jusqu'à
trois essais
sur une plage de 60
secondes du démarrage

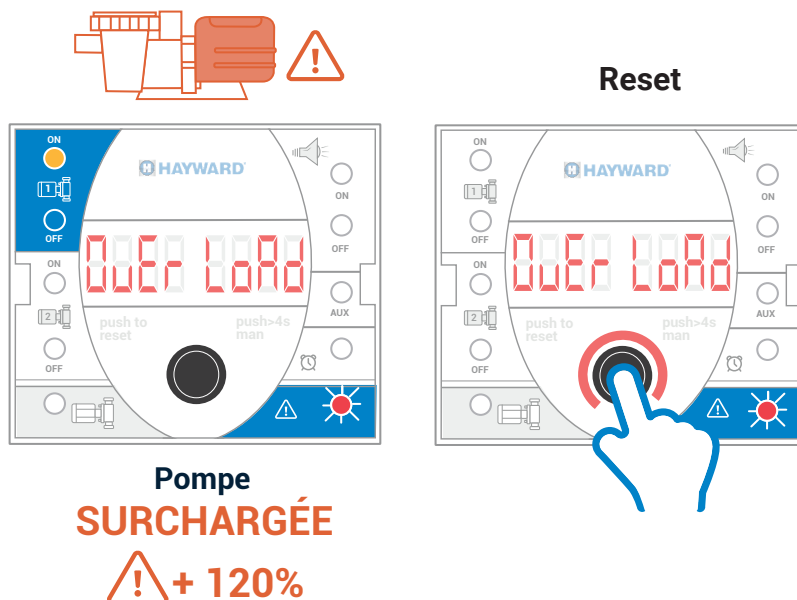

○ Système de prévention du blocage du rotor (protection antiblocage)

Toutes les 23 heures HPOWER active l'épurateur pendant 1 seconde pour éviter le blocage de son moteur, afin d'éviter d'éventuelles défaillances après de longues périodes d'inactivité.

7. Éléments additionnels de contrôle

Épurateur

▶ FONCTIONNEMENT

L'épurateur se met en marche dès que le contact est fermé.

⏸ ARRÊT

L'épurateur s'arrête dès que le contact est ouvert.

Éclairage

ON

Les projecteurs s'allument dès que le contact est fermé.

OFF

Les projecteurs s'éteignent dès que le contact est ouvert.

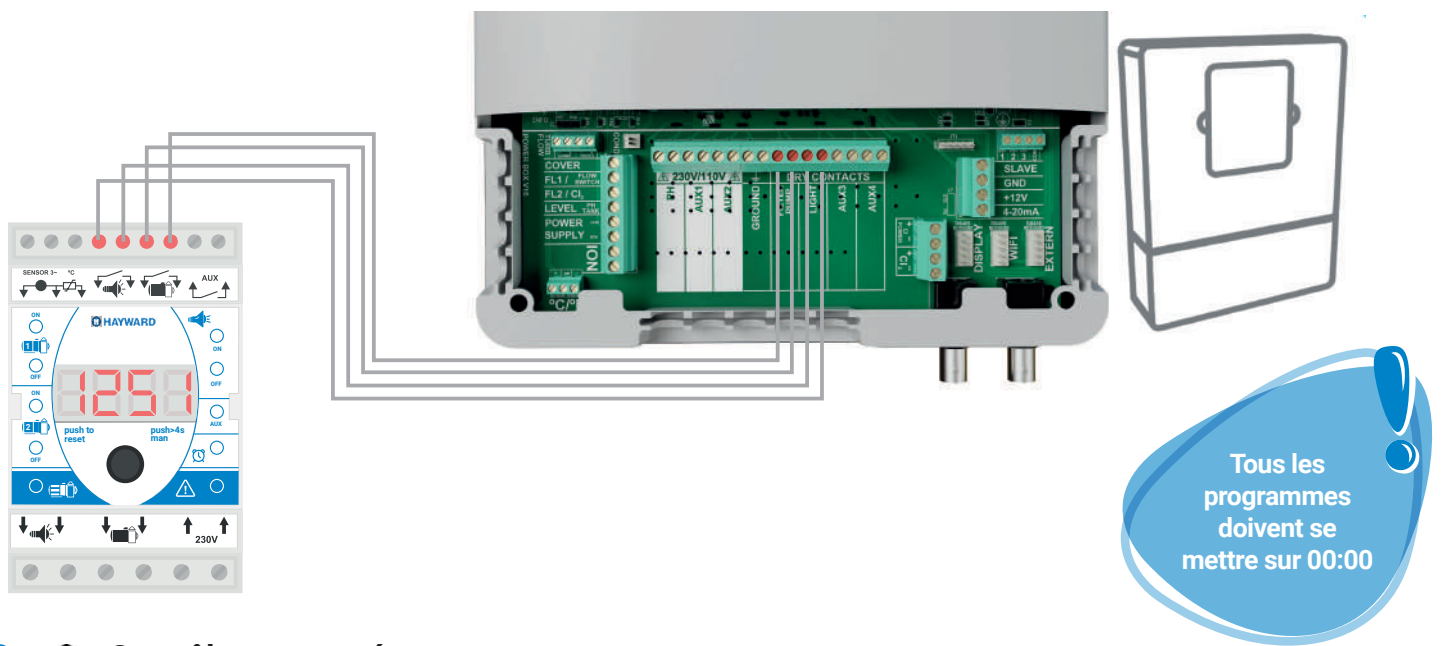

Contrôle par température

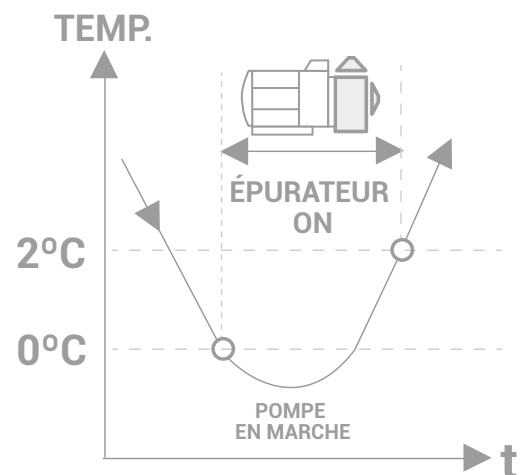
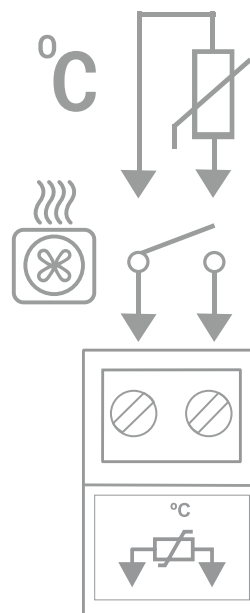

Contact de la pompe de chaleur. **Une fois activé, le symbole "oC" s'affiche sur l'écran.**

Captur externe de température ambiante (**antigel**). Il met en marche l'**épurateur** si la **température ambiante** est très basse.

○ Contact auxiliaire

FRANÇÉS (FR)

Le contact du **relai auxiliaire (AUX)** est libre de potentiel et s'active en **même temps** que la **pompe de l'épurateur**.

Il peut être utilisé en série avec l'alimentation de pompes de dosage, chlorinateurs salins ou tout autre dispositif (**250V / 5A maximum**) qui doit fonctionner en même temps que la pompe de l'épurateur.



8. Lecture des données

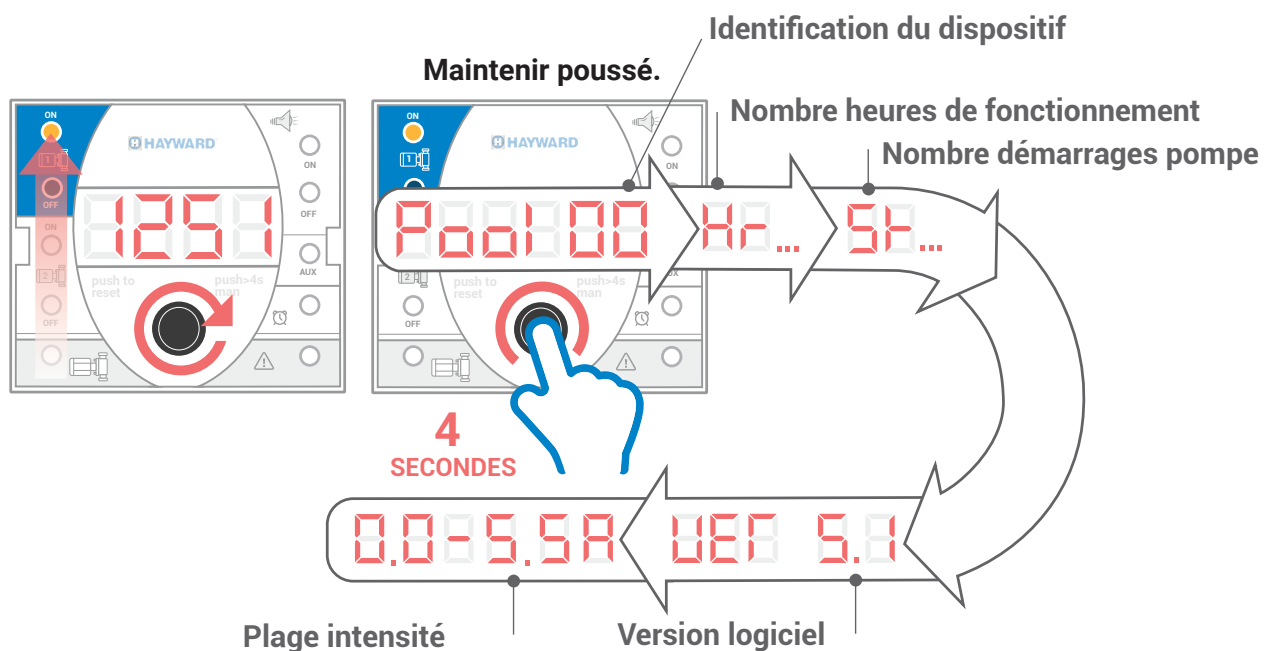

9. Bluetooth (Uniquement pour modèles-B)

FRANÇAIS (FR)

- 1. Télécharger l'App "H- POWER".

App android

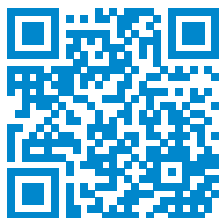

App iOS



- 2. Ouvrir App et ACCOUPLER l'unité.

- 3. Interface de l'application.

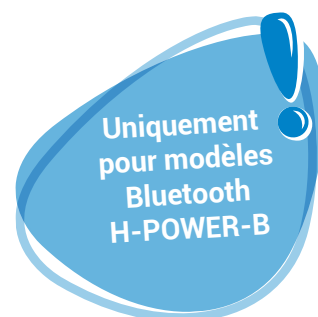

Pousser

Accoupler Bluetooth

Fonctionnement par température

Contrôle manuel épurateur

ON **OFF**

Alarme épurateur/reset

Contrôle éclairage par programme

ON **OFF**

Contrôle éclairage par programme

Contrôle manuel éclairage

RGB **COLOR**

Changement couleur éclairage

SET

Programmation

Épurateur

Programme 1

Programme 2

Éclairage

Programme

00:00:00

12:24:36

09:40- 20:25-

22:00- 02:00-

07:00- 03:00-

10. Spécifications

FRANÇÉS (FR)

Alimentation	230VAC / 400VAC - 50/60Hz
Sortie pompe	14A, 230VAC
Sortie éclairage (selon modèle)	230VAC / 5A 12 VAC / 50W 12VAC / 100W 12VAC / 300W
Signalétique	En marche, Alarme, Programmes de filtrage, Programme d'éclairage, Sortie auxiliaire et Heure actuelle
Protections	Surcharge moteur, Antiblocage
Protection surcharge	20% au-dessus de l'intensité mesurée au réglage
Affichage LED 4 chiffres	Heure actuelle, réglages et alarmes
Relai auxiliaire	Contactlibredetension250V/5Amaximum
Section maximale des bornes	4mm ² (puissance) / 2,5mm ² (contrôle)
IP/Température	IP65/-10°...+55° C
Logiciel	V.5
Directives	- 2016 - D.C. 2014 / 30 / CE EMC D.C. 2014 / 35 / UE C.E. ROHS EN61558 Transformateur projecteurs.
Options	Interface Bluetooth (-B) Différentiel (-D) Transformateur 50W (T50) Transformateur 100W (T100) Transformateur 300W (T300) Télécommande par radio Capteur externe de température ambiante

○ Référence

HPOW230BDT50

230: Alimentation

400: Alimentation

B: Branchement
bluetooth

T50: Transformateur 50W

T100: Transformateur 100W

T300: Transformateur 300W

D: Différentiel



3. Control module/ Pilots

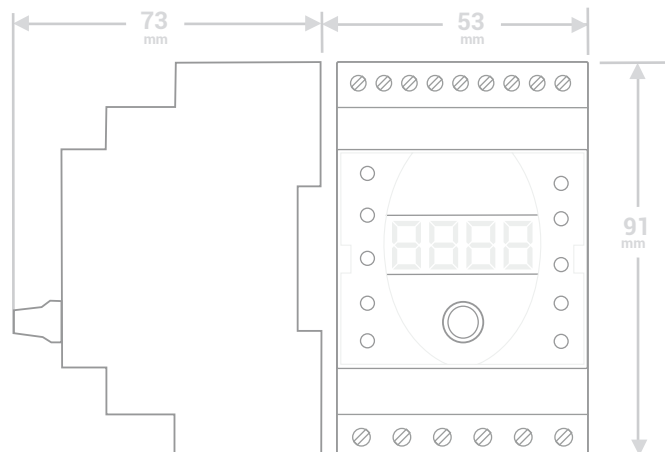
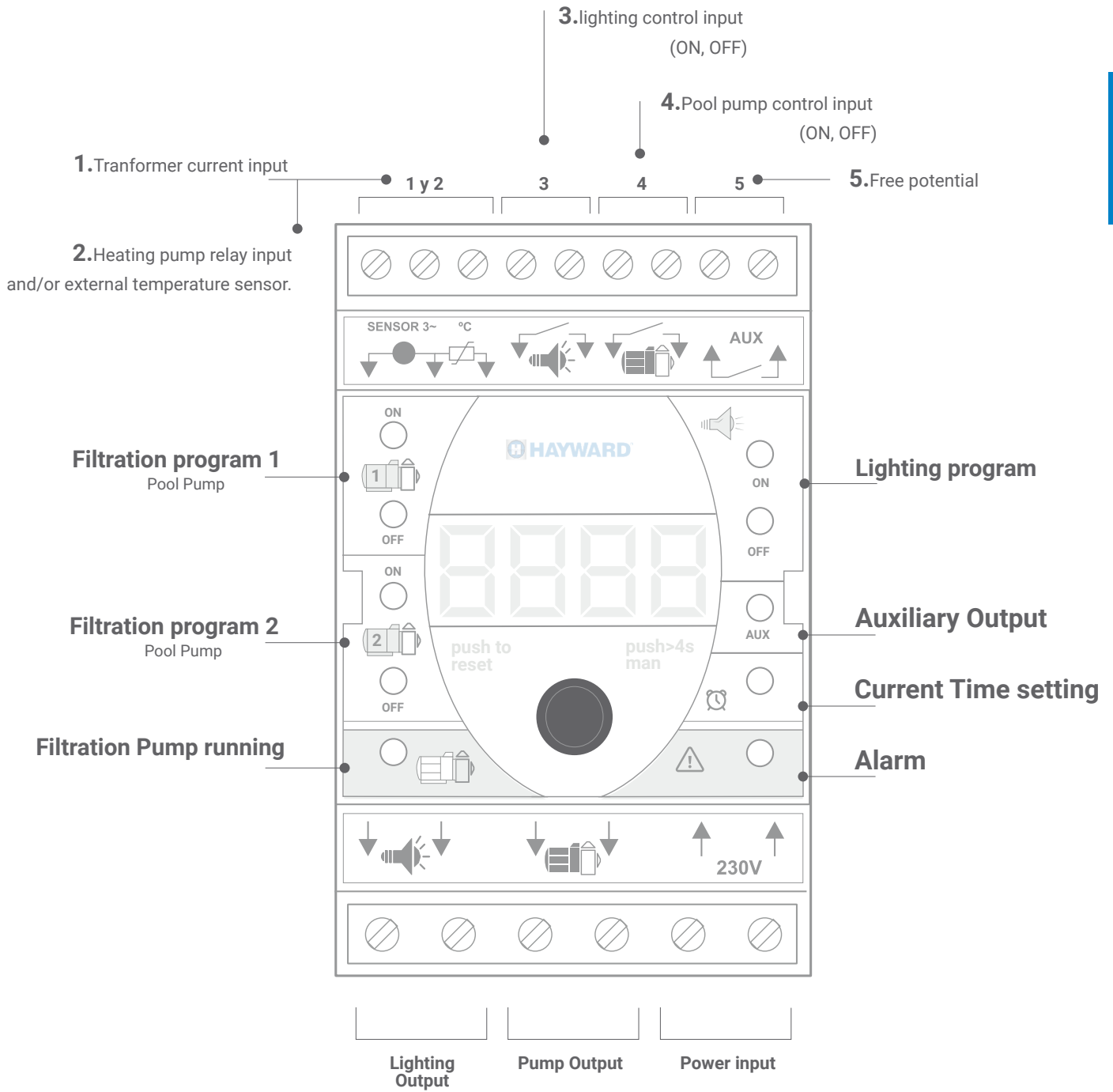

Bluetooth models are synchronized automatically with the smartphone current time.

1. Time setting

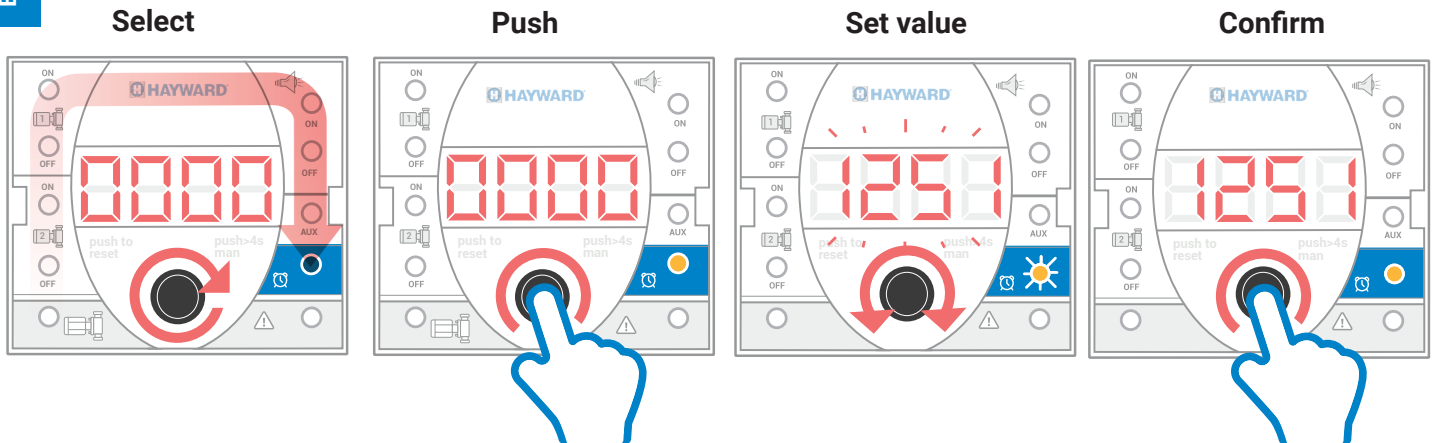

2. Filtration and lighting program setting

LED STATUS

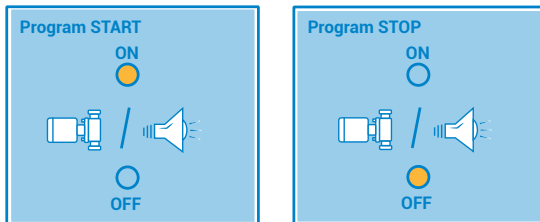

To cancel a program, select same time ON / OFF

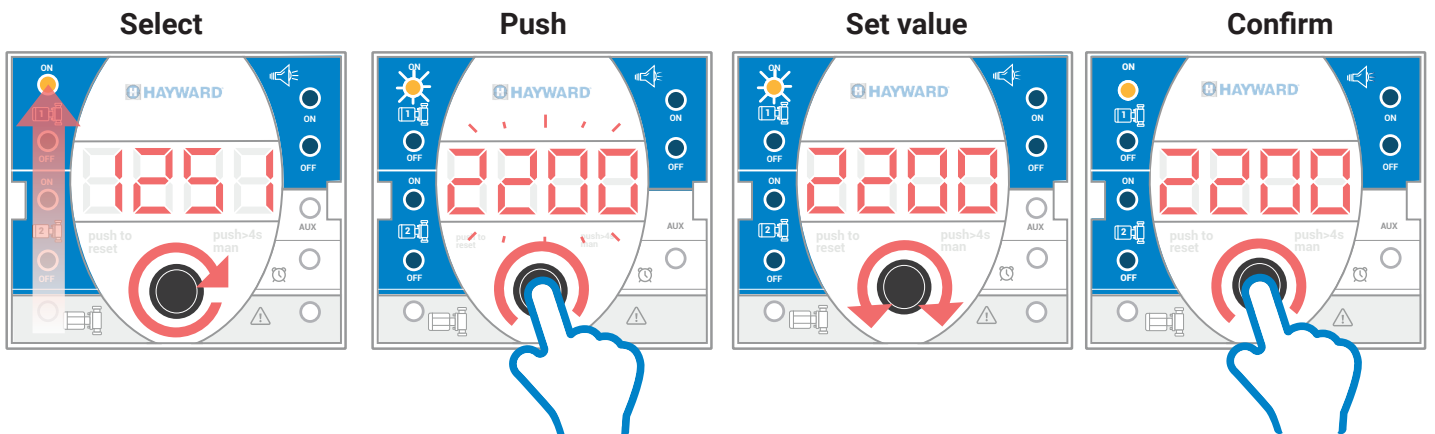

5. Manual mode / Filtration - Lights

Manual Filtration START / STOP

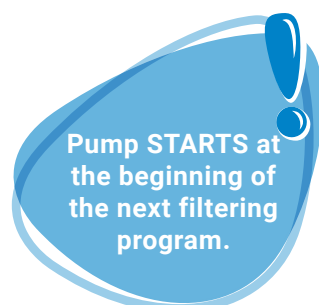
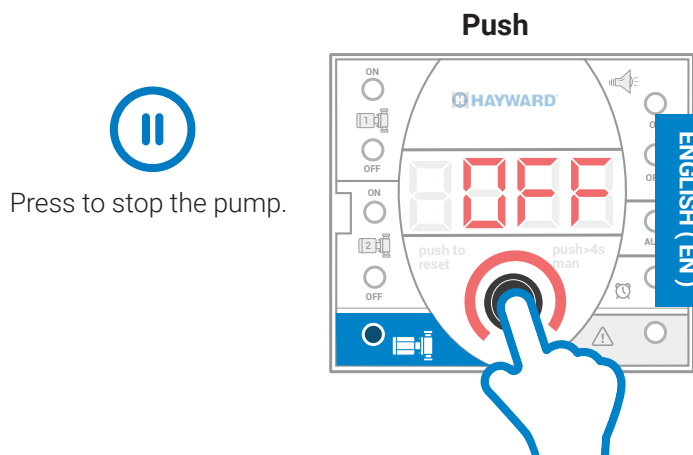
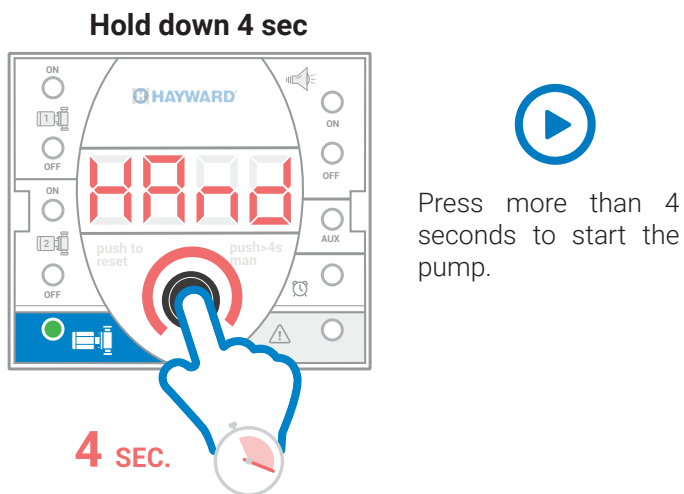

Manual Lighting ON / OFF

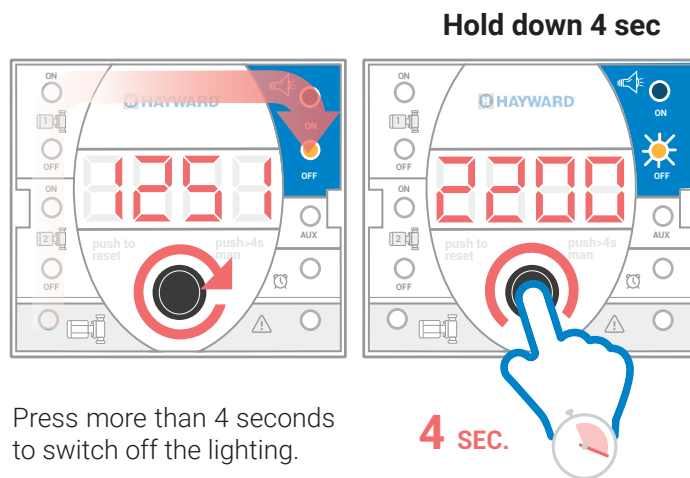
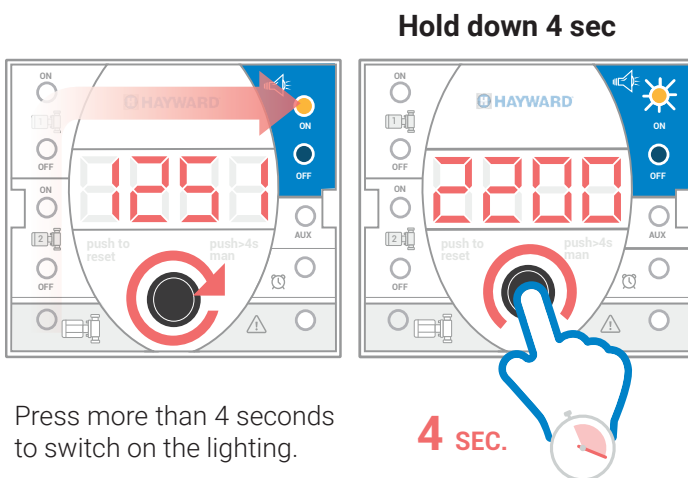

6. Filtration Pump Protection

Automatic calibration overload procedure.

Automatic setting of motor overload. H-POWER auto adjust with the first startup.

ENGLISH (EN)

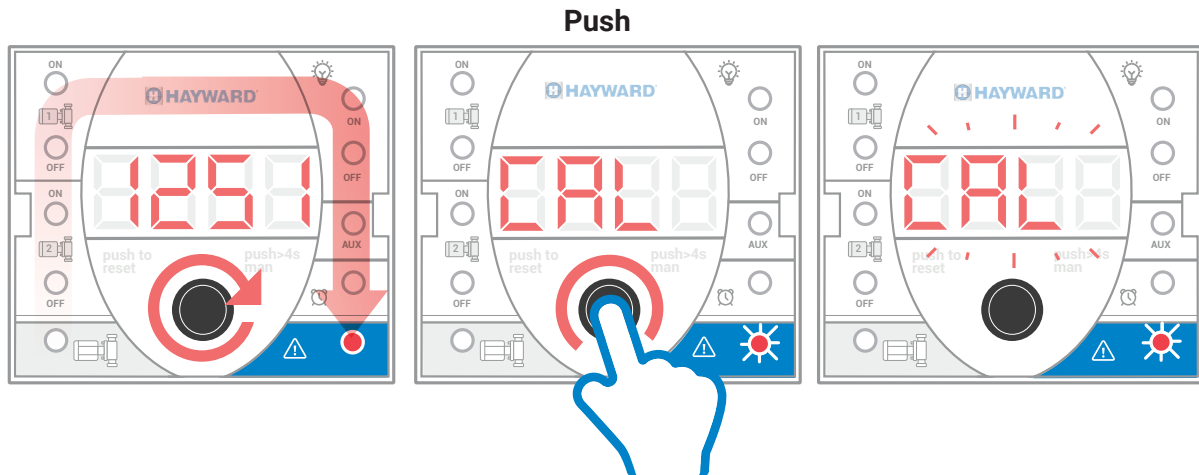

Once confirmed pump will be self-adjusted during the first 8 min.

Overload and reset

Overload possible alarms:

- Pump is not calibrated.
- Pump is blocked.

In case of overload K-Power will execute upto three attemps within a 60 sec. interval

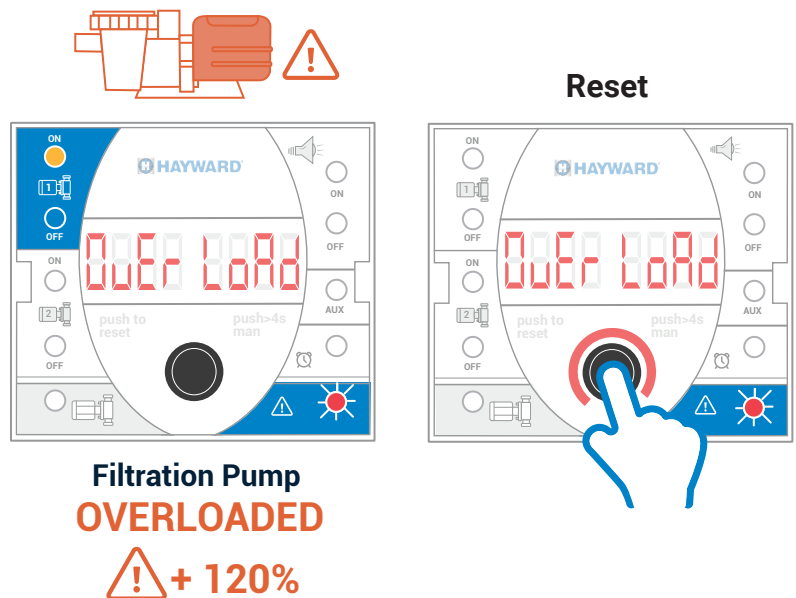

Jammed impeller protection

Every 23 hours H- POWER will run the pump during 1 sec, to avoid possible failing in case of long period of inactivity.

7. External ON / OFF

Filtration



START

When the contact is closed, the pump will start up.



STOP

When the contact is opened, the pump will be paused.

Lights

ON

When the contact is closed, the lights will turn on.

OFF

When the contact is opened, the lights will turn off.

ENGLISH (EN)

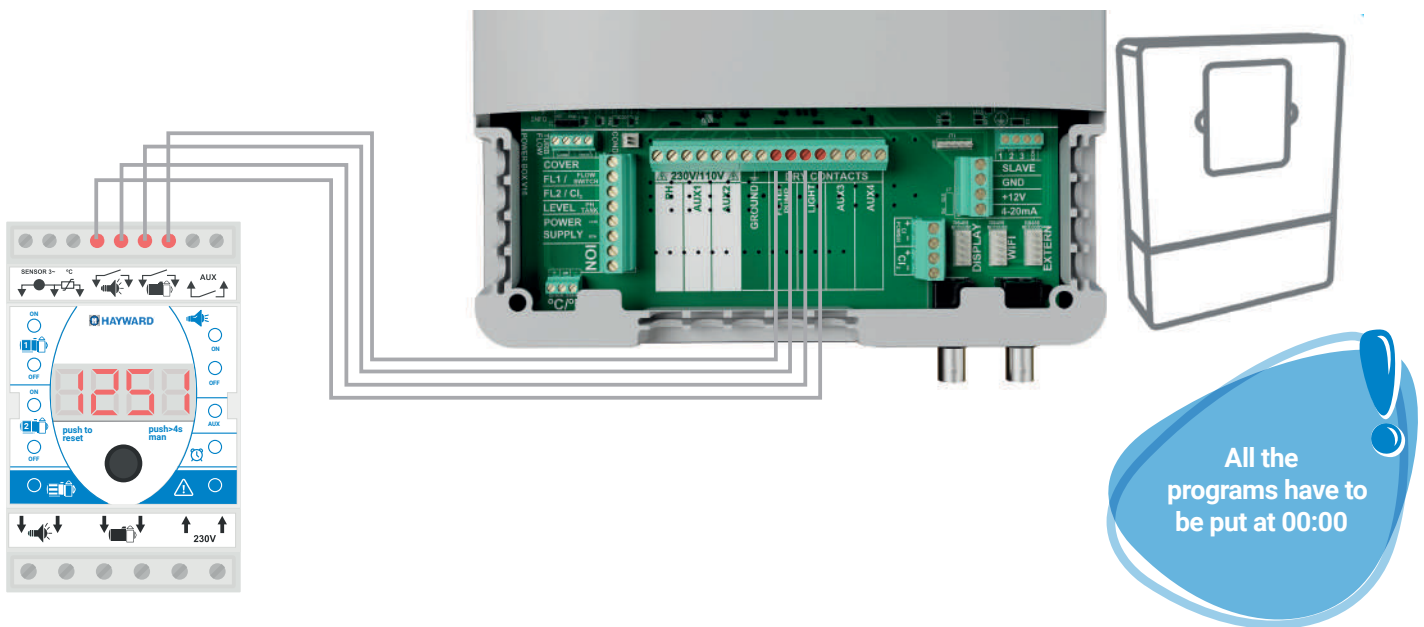

Temperature Control

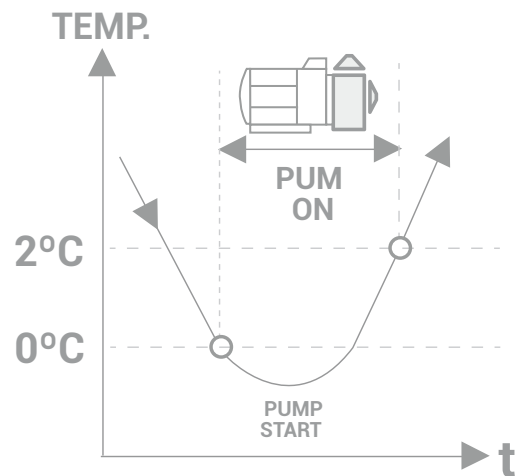
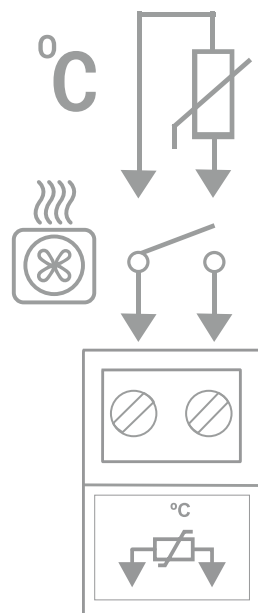
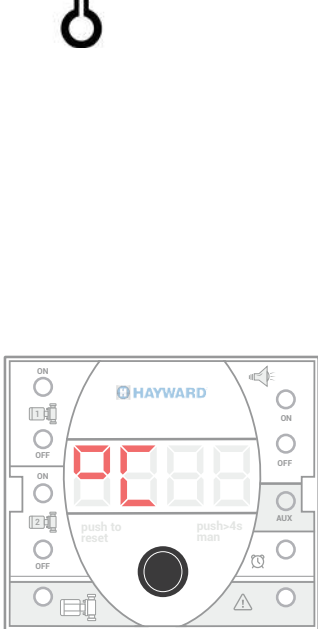

Display will show °C when activated.

Frost protection (sensor optional).

Filtration will start in case of **very low temp.**

○ Auxiliary contact (AUX LED)

Auxiliary contact relay is activated simultaneously with the pump output. Potential free relay

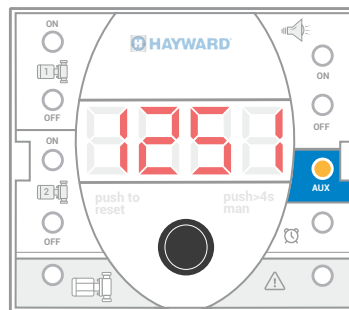

ENGLISH (EN)

8. Pump operation data download

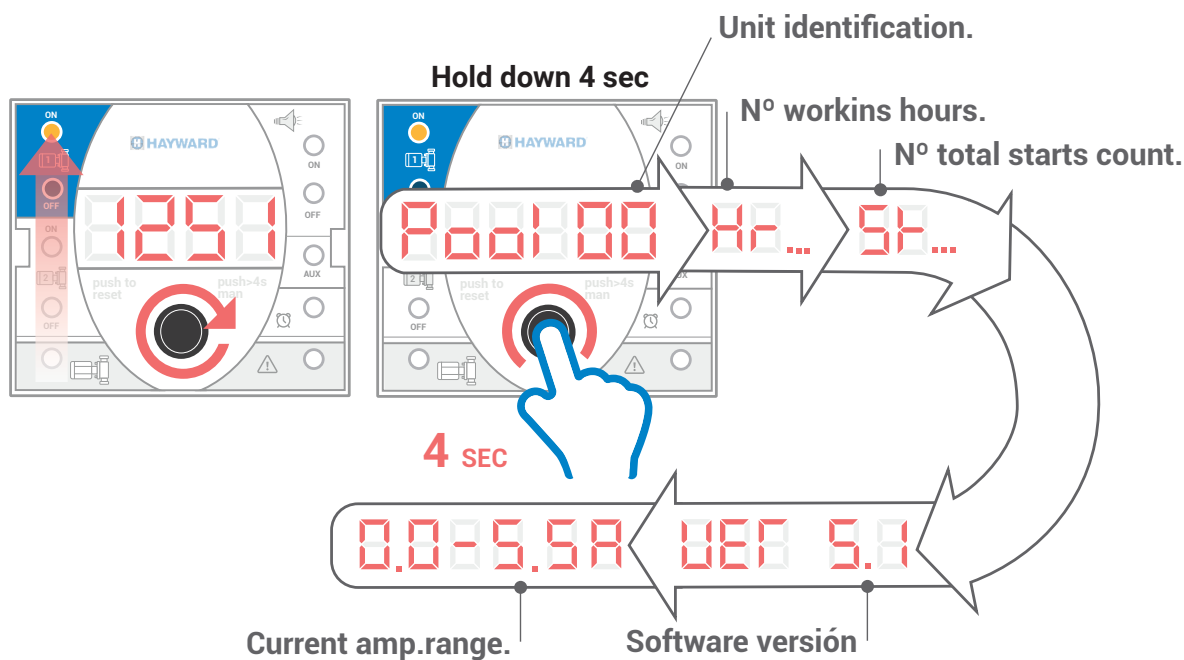

9. Bluetooth (Only modelo - B)

- 1. Download la App " H-POWER ".

App android



App iOS



ENGLISH (EN)

- 2. Open App and Pairing.

- 3. Application Interface

**Only Bluetooth
K-POWER - B**

Temperature control ON

Manual filtration

Manual lighting

Bluetooth pairing

Filtration Alarm / reset

Control Via filtration program

Control Via lighting program

Scene colour change

Program

Filtration

Program 1

Program 2

Ligthing

Program

Push for

00:00:00

12:24:36

ON OFF

ON OFF

RGB COLOR

SET

09:40 20:25

22:00 02:00

07:00 03:00

10. Specification

Power supply	230VAC / 400VAC - 50/60Hz
Pump output	14A, single-phase models 230VAC
Lighting output (according to the model)	230VAC / 5A 12 VAC / 50W 12VAC / 100W 12VAC / 300W
Pilot lights	Filtration ON, Alarm, Time programs, Ligthing program, Auxiliary output, Current time
Protections	Motor overload
Overload protection	20% over calibrated current
4-digit LED display	Current time, Settings, Alarms
Auxiliary relay	Free-voltage contact 250V / 5A
Maximum terminal cross-section	4mm ² (power) / 2.5mm ² (control)
IP/Temperature	IP65/-10°...+55° C
Software	V.5
Directives	- 2016 - D.C. 2014 / 30 / CE EMC D.C. 2014 / 35 / UE C.E. ROHS EN61558 Light power transformer
Options	Bluetooth interface (-B) RCCD (- D) Transformer T50 Transformer T100 Transformer T300

Product orden form

HPOW230BDT50

230: Power inlet	T50: Transformer 50W
400: Power inlet	T100: Transformer 100W
B: Transformer Bluetooth	T300: Transformer 300W
D: RCCB (- D)	

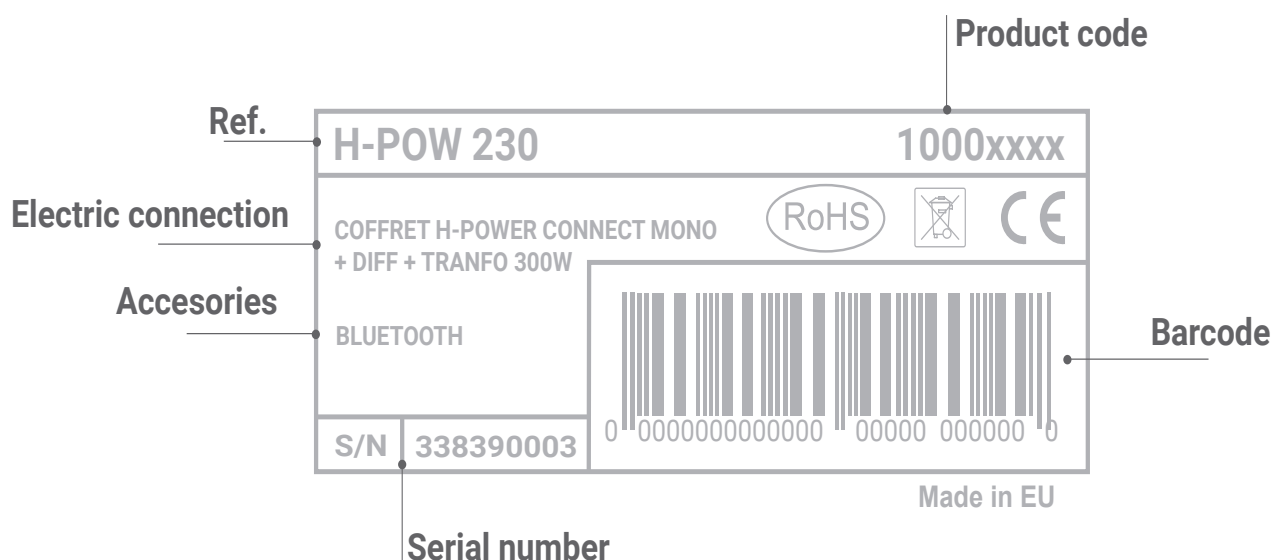

3. Módulo de control / Pilotos

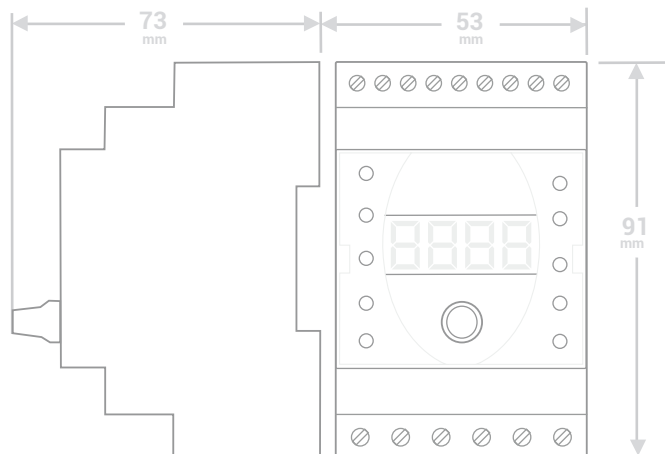
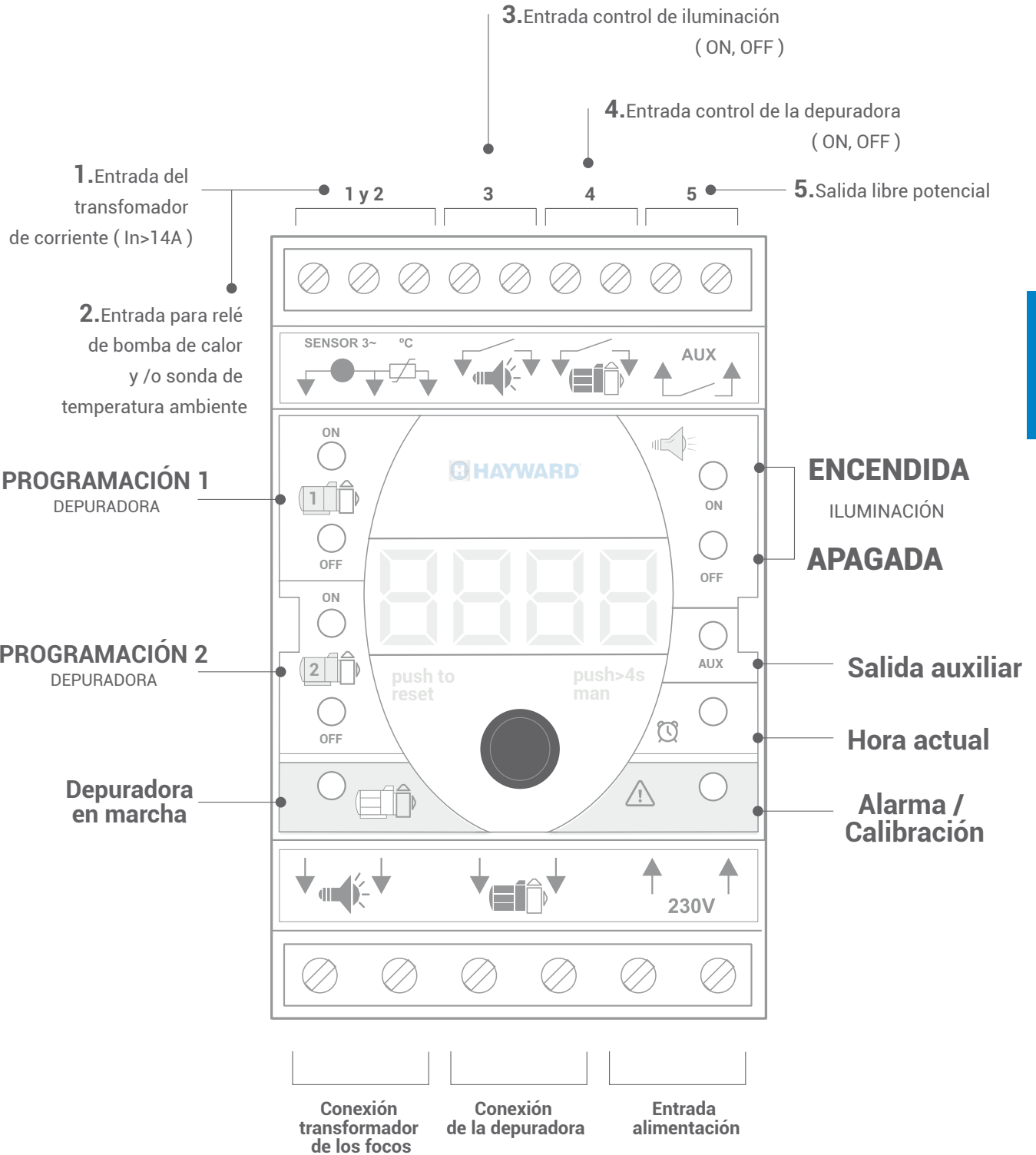

Los modelos con Bluetooth se sincronizan automáticamente con la hora del Smartphone / Tablet

1. Ajuste de la hora actual

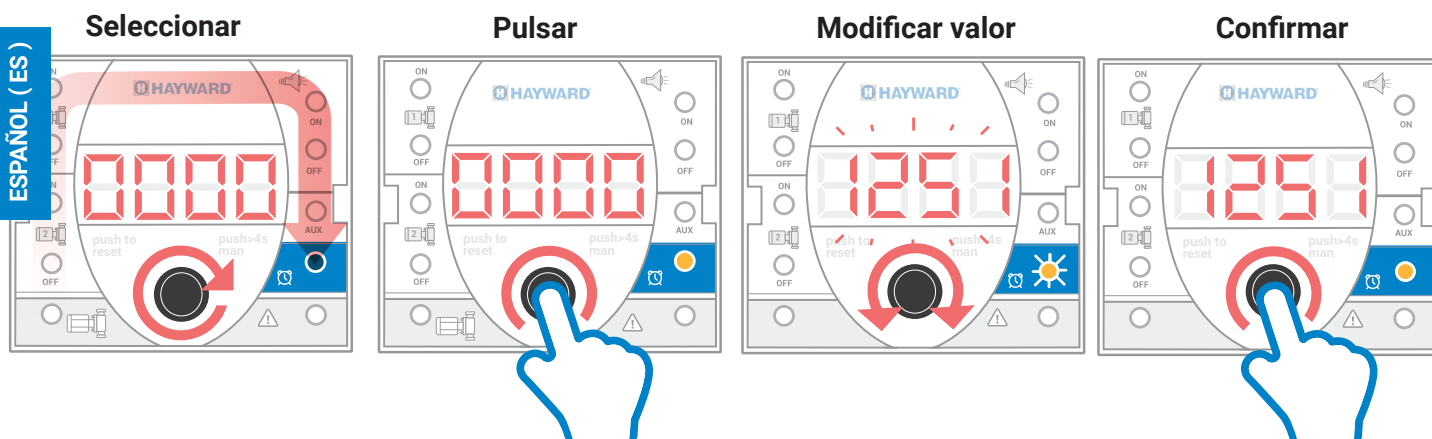

2. Programas de filtrado e iluminación

ESTADOS LUCES

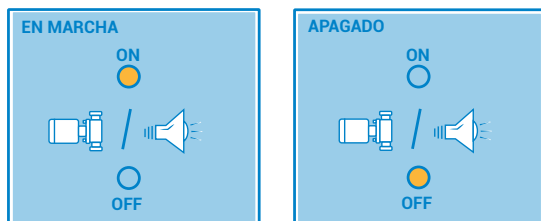

Para anular un programa seleccione la misma hora en ON y en OFF

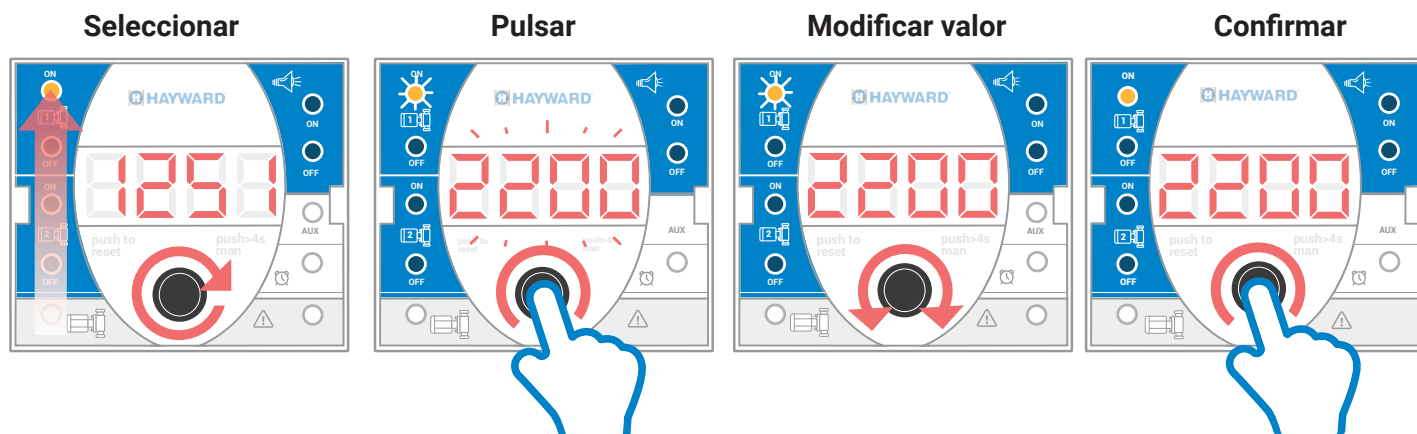

5. Control MANUAL / Filtrado - Iluminación

○ MARCHA / PARO DE FILTRADO

Mantener pulsado

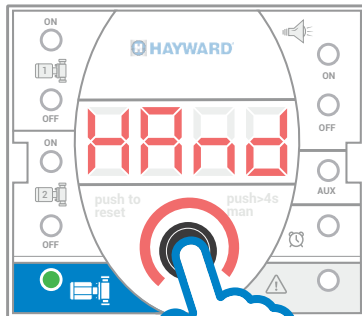

4
SEGUNDOS



Pulsar más de 4 segundos para poner en marcha la depuradora.

Se apagará al finalizar el siguiente programa de filtrado.

Pulsar

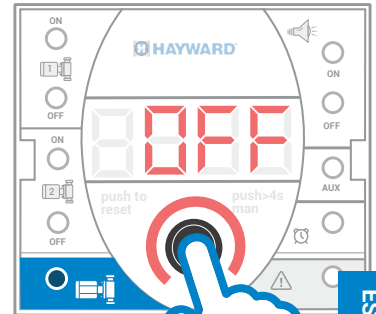

Pulsar para pausar la depuradora.

Se encenderá al inicio del siguiente programa de filtrado.

ESPAÑOL (ES)

○ ENCENDIDO / APAGADO DE FOCOS

Mantener pulsado

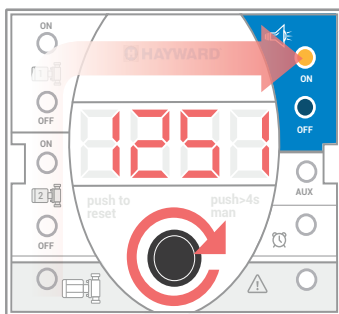

Pulsar más de 4 segundos para encender los focos.

4
SEGUNDOS

Se apagarán de forma automática pasadas 6 horas.

Mantener pulsado

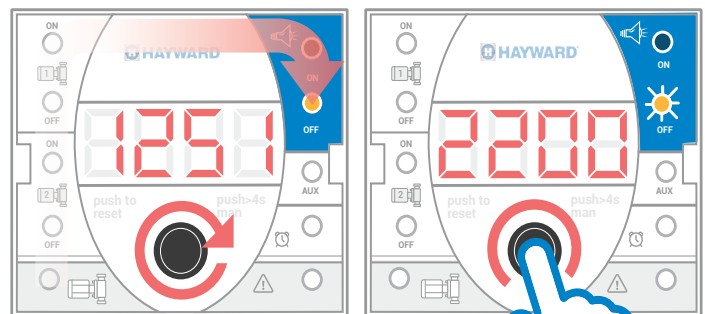

Pulsar más de 4 segundos para apagar los focos.

4
SEGUNDOS

Se encenderán al inicio del siguiente programa de iluminación.

6. Protección depuradora

○ Calibración de la protección de la bomba

El equipo se autoajusta con la 1ª puesta en marcha. Si se desea efectuar una nueva calibración automática, seguir los siguientes pasos:

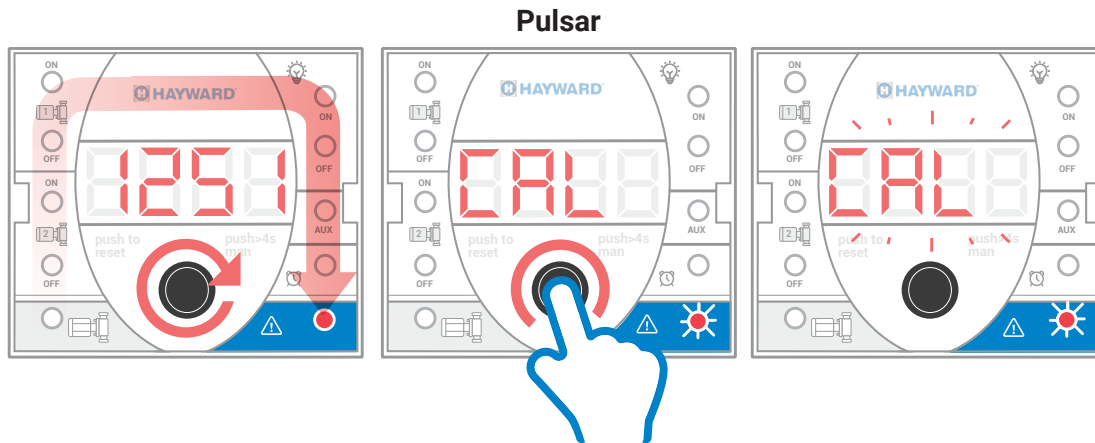

Una vez confirmada la función "calibración", la bomba se autoajustará durante los primeros 8 minutos de marcha.

○ Sobrecarga (overload) y reset

Posibles causas:

- Bomba no calibrada.
- Bomba bloqueada.

En caso de **sobrecarga** el equipo realiza hasta tres intentos con un intervalo de 60 segundos de arranque.

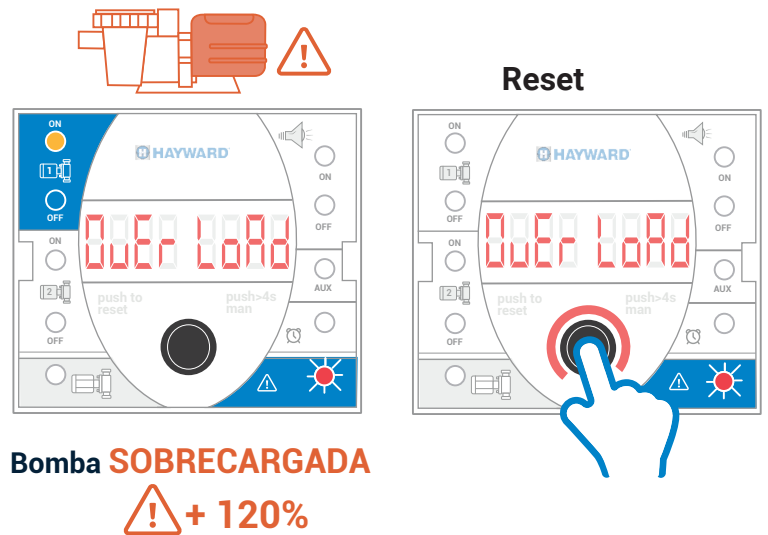

○ Sistema preventivo de bloqueo rotor (protección anti-bloqueo)

Cada 23 horas HPOWER accionará la depuradora durante 1 segundo evitando el bloqueo del motor de la misma. Así se evitan posibles fallos tras largos periodos de inactividad.

7. Elementos adicionales de control

Depuradora



MARCHA

Al cerrar el contacto se pondrá en marcha la depuradora.



PARO

Al abrir el contacto se pausará la marcha de la depuradora.



Iluminación

ON

Al cerrar el contacto se encenderán los focos.

OFF

Al abrir el contacto se apagarán los focos.

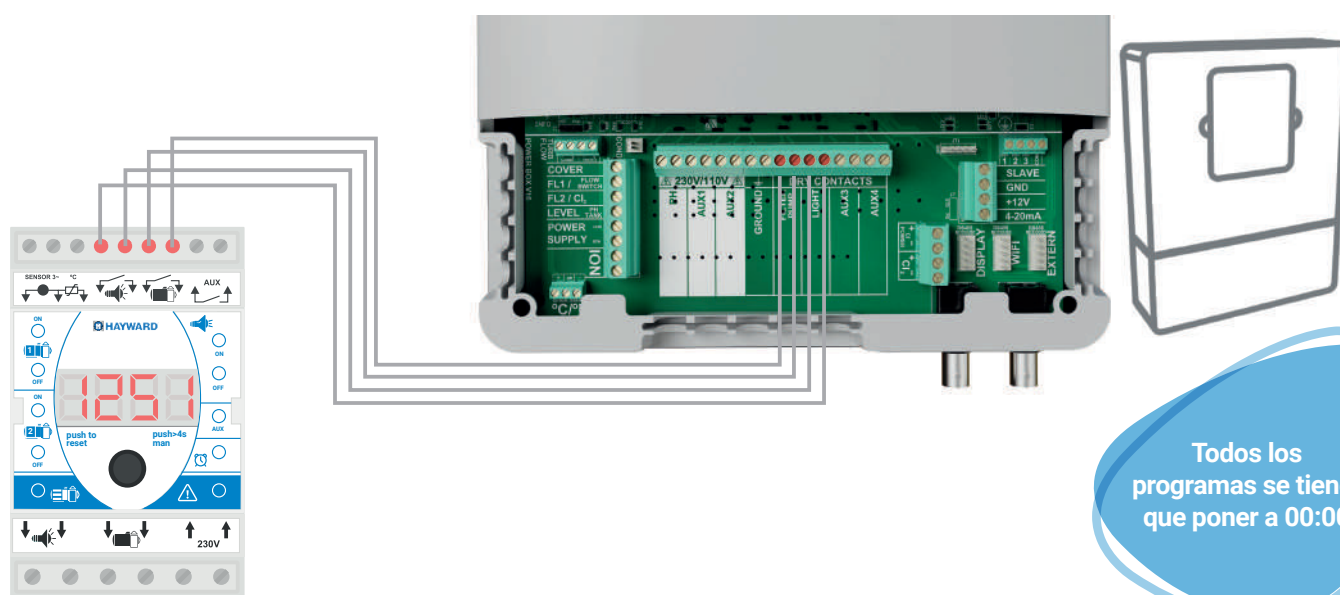

ESPAÑOL (ES)

Control por temperatura

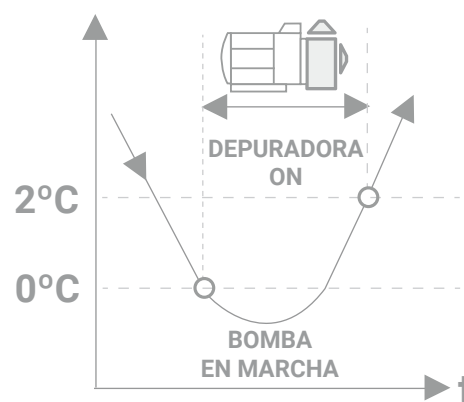
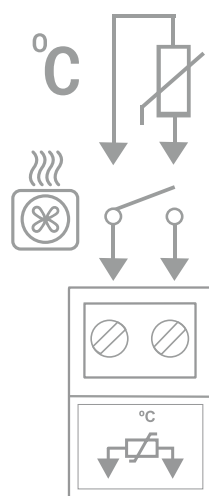

Contacto de la bomba de calor. **Cuando se activa** aparece el **símbolo "°C"** en la pantalla.

Sonda externa de temperatura ambiente (**anti-heladas**). Pone en **marcha la depuradora** cuando la **temperatura ambiente** es muy baja.

○ Contacto auxiliar (AUX)

El contacto del **relé auxiliar (AUX)** es libre de potencial y **se activa al mismo tiempo** que la **bomba depuradora**.

Puede utilizarse en serie con la alimentación de bombas dosificadoras, cloradores salinos o cualquier equipo (**250V / 5A máximo**) que deba funcionar al mismo tiempo que la bomba depuradora.

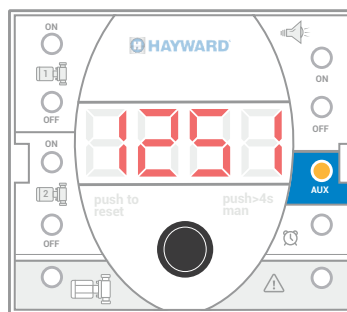

8. Lectura de Datos

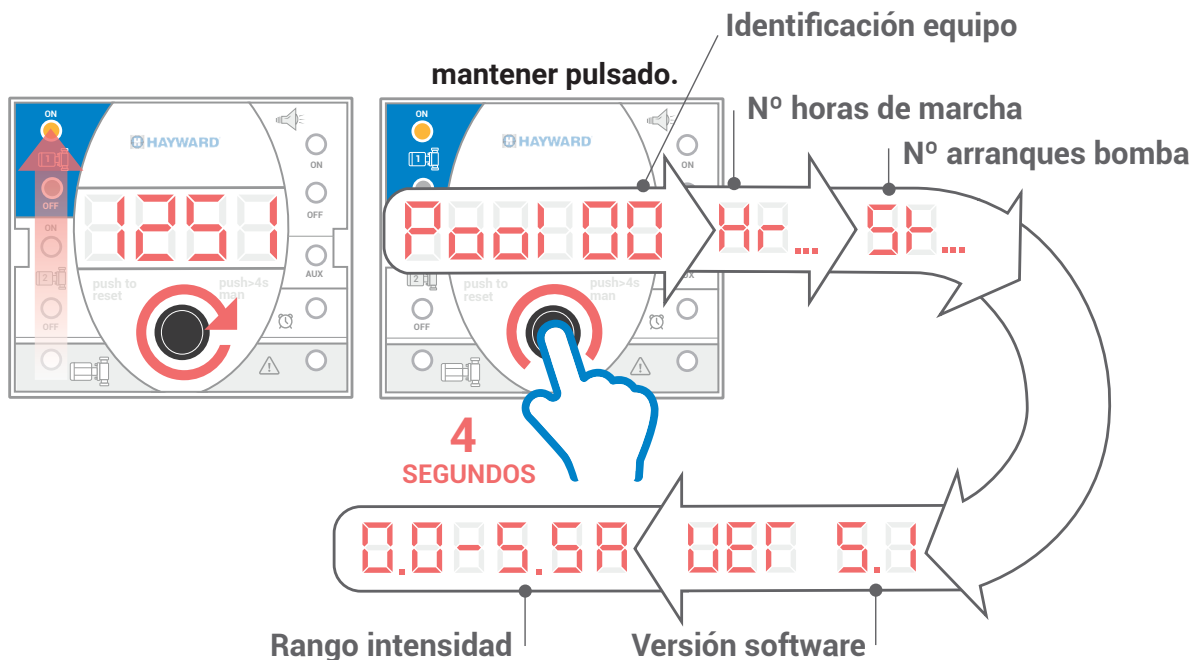

9. Bluetooth (sólo modelo - B)

- 1. Descargar la App "HAYWARD POWER".

App android

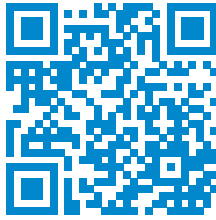

App iOS

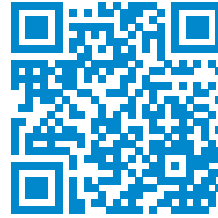

- 2. Abrir App y EMPAREJAR la unidad.

- 3. Interfaz de la aplicación.

Pulsar

Emparejar bluetooth

Marcha por temperatura

Control manual depuradora

Control manual Iluminación

Alarma depuradora / reset

Control depuradora con programa

Control iluminación con programa

Cambio color iluminación

Programación

Sólo para modelos Bluetooth H-POWER - B

ESPAÑOL (ES)

Depuradora

Programa 1

Programa 2

Iluminación

Programa

The image shows two screenshots of the HAYWARD POWER app. The top screenshot displays the main control interface with buttons for 'ON' and 'OFF' for both the purifier and lighting, along with a 'SET' button for programming. The bottom screenshot shows the programming screen for the purifier and lighting, with two programs each, showing time ranges for when they are turned on and off.

10. Especificaciones

Alimentación	230VAC / 400VAC - 50/60Hz
Salida bomba	14A, 230VAC
Salida iluminación (según modelo)	230VAC / 5A 12 VAC / 50W 12VAC / 100W 12VAC / 300W
Señalización	Bomba en marcha, Alarma, Programas de filtrado, Programa de iluminación, Salida auxiliar y Hora actual
Protecciones	Sobrecarga motor, Anti-bloqueo
Protección de sobrecarga	20% por encima de la intensidad medida en calibración
Display LED 4 dígitos	Hora actual, Ajustes y Alarmas
Relé auxiliar	Contacto libre de tensión 250V / 5A máximo
Sección máxima de bornas	4mm ² (potencia) / 2,5mm ² (control)
IP/Temperatura	IP65/-10°...+55° C
Software	V.5.1
Directivas	- 2016 - D.C. 2014 / 30 / CE EMC D.C. 2014 / 35 / UE C.E. ROHS EN61558 Transformador de focos.
Opciones	Interfaz Bluetooth (-B) Diferencial (-D) Transformador 50W (T50) Transformador 100W (T100) Transformador 300W (T300) Control remoto via radio Sonda externa de temperatura ambiente

Referencia

HPOW230BDT50

230: Alimentación
400: Alimentación
B: Conexión bluetooth

T50: Transformador 50W
T100: Transformador 100W
T300: Transformador 300W

D: Diferencial

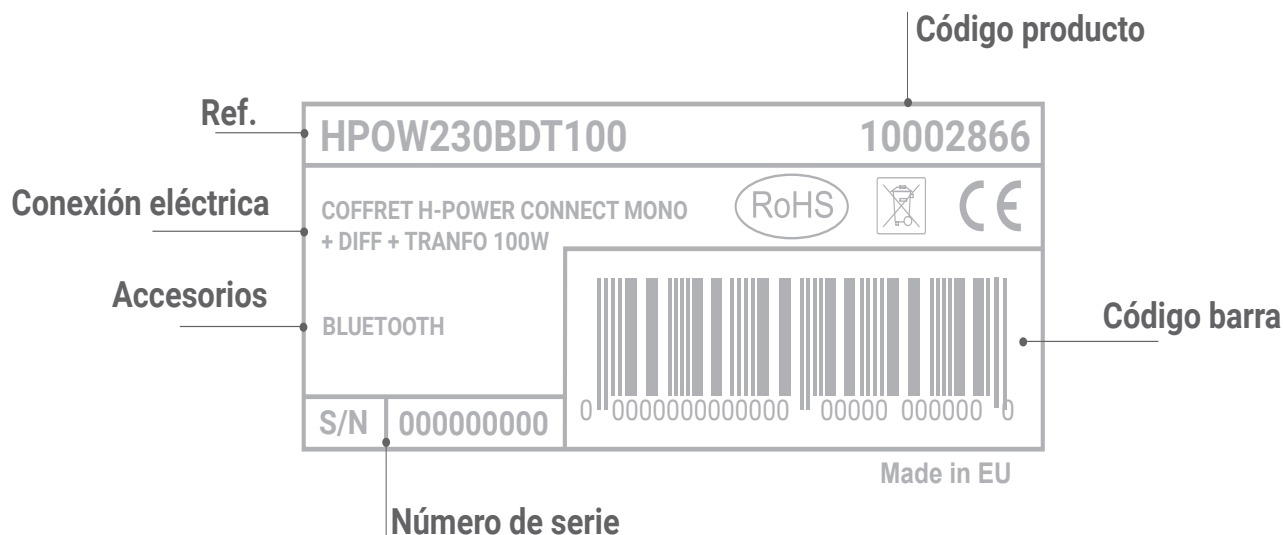

3. Módulo de controlo/Pilotos

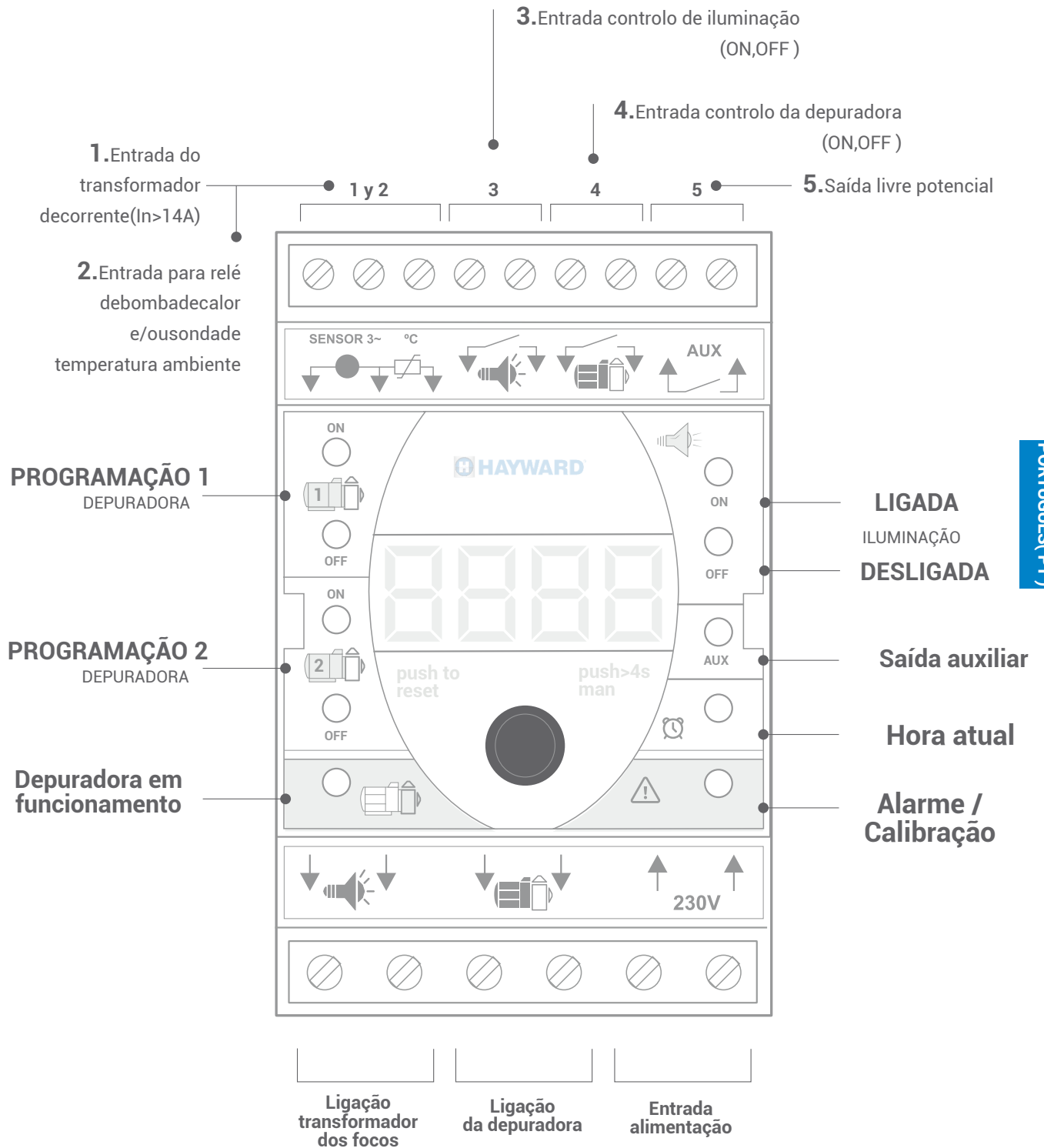

PORTUGUÊS (PT)

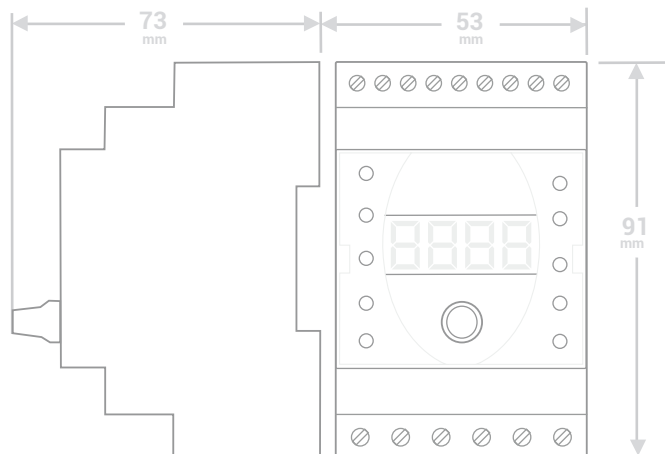

Os modelos com Bluetooth sincronizam-se automaticamente com a hora do Smartphone / Tablet.

1. Ajuste da hora atual

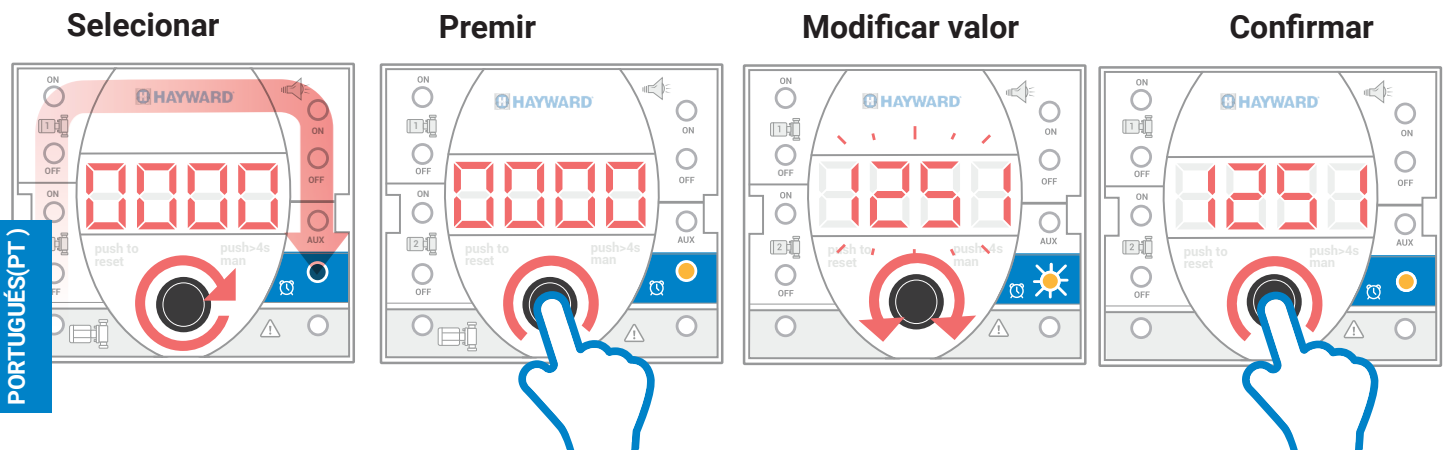

2. Programas de filtração e iluminação

ESTADOS LUZES

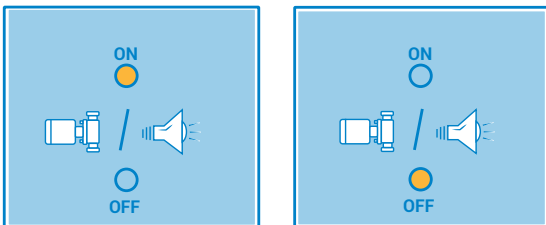

Para anular um programa selelegione a mesma hora em ON e em OFF

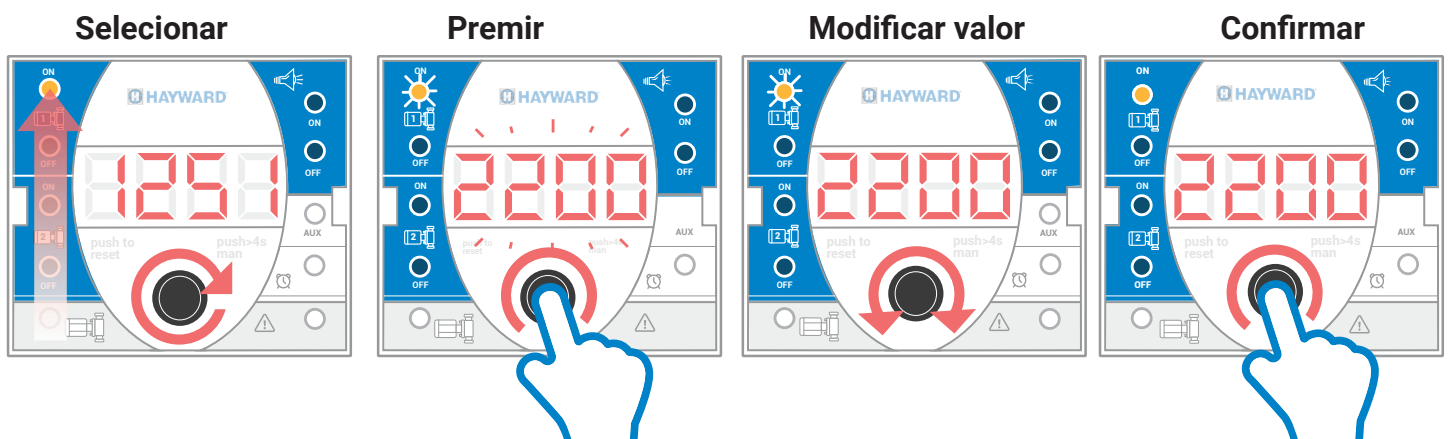

5. Controlo MANUAL/Filtração-Iluminação

○ FUNCIONAMENTO / PARAGEM DE FILTRAÇÃO

Manter premido

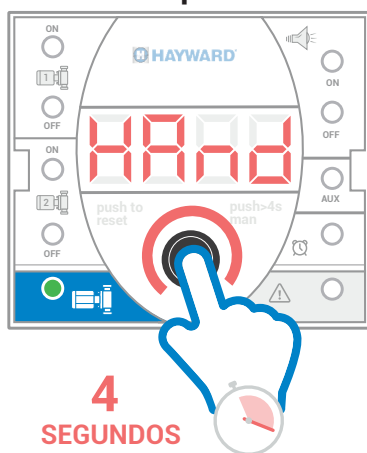

Carregar mais de 4 segundos para colocar a depuradora em funcionamento.

Premir

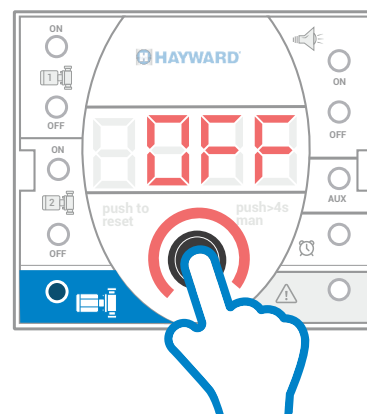

Premir para pausar a depuradora.

Desliga-se no final do seguinte programa de filtração.

Liga-se no início do seguinte programa de filtração.

PORTUGUÊS (PT)

○ LIGAÇÃO/DESLIGAÇÃO DE FOCOS

Manter premido

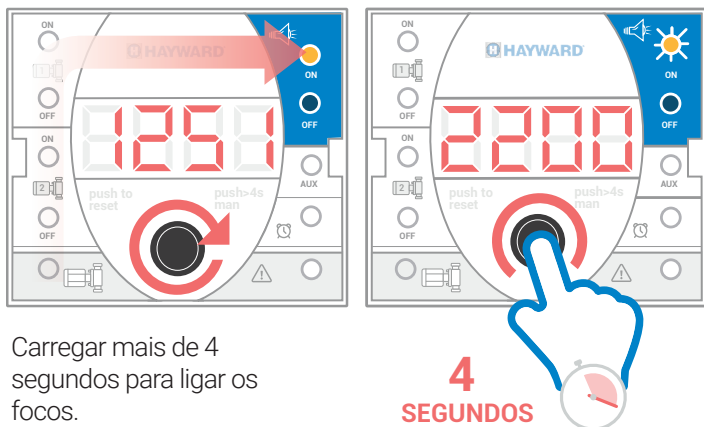

Carregar mais de 4 segundos para ligar os focos.

Desligam-se de forma automática passadas 6 horas.

Manter premido

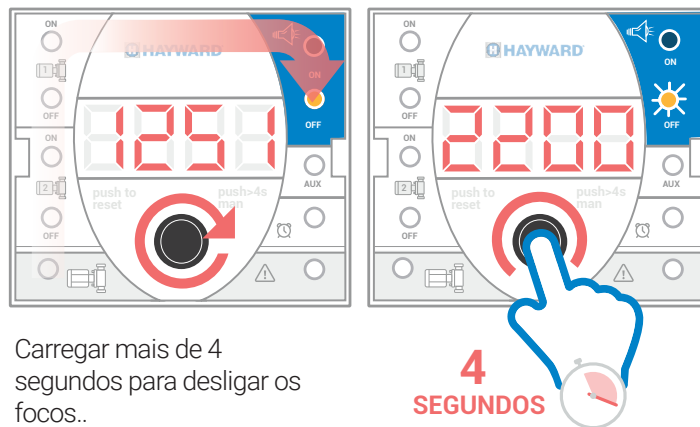

Carregar mais de 4 segundos para desligar os focos..

Ligam-se no início do seguinte programa de iluminação.

6. Proteção depuradora

Calibração da proteção da bomba

O equipamento autoajusta-se com o 1º início de funcionamento. Se desejar efetuar uma nova calibração automática, seguir os seguintes passos:

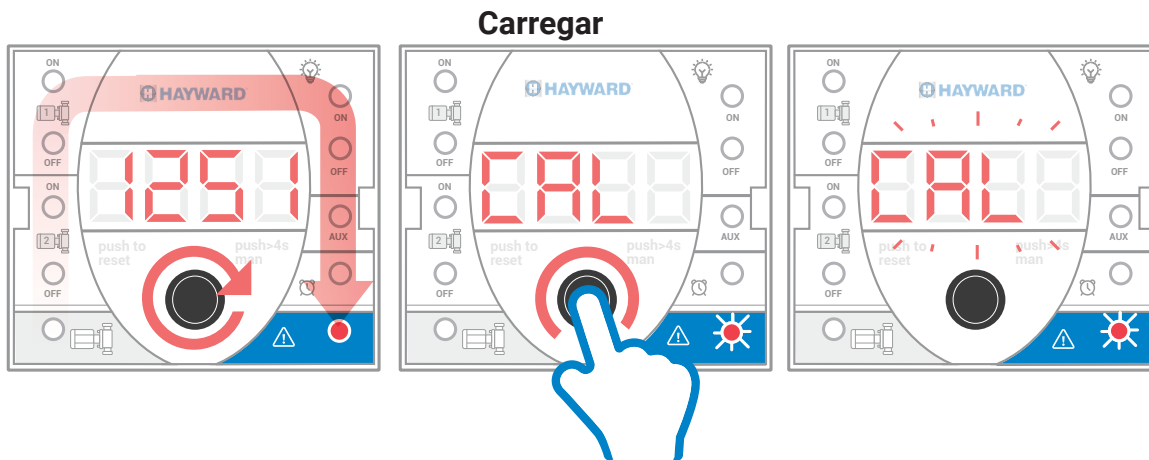

PORTUGUÊS(PT)

Após ter confirmado a função " calibração ", a bomba irá autoajustar-se durante os primeiros 8 minutos de funcionamento.

Sobrecarga (overload) e reset

Possíveis causas::

- Bomba não calibrada.
- Bomba bloqueada.

Em caso de sobrecarga o equipamento realiza até três tentativas com um intervalo de 60 segundos de arranque

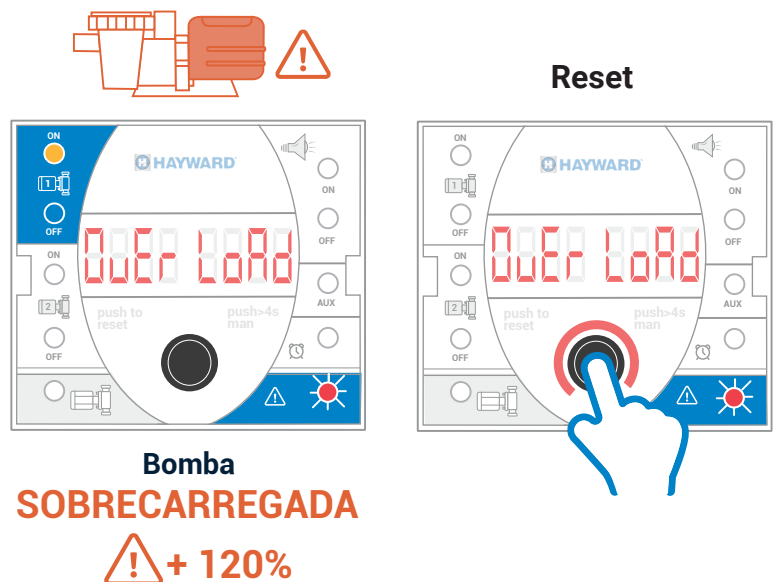

Sistema preventivo de bloqueio rotor (proteção antibloqueio)

De 23 em 23 horas, HPOWER acionará a depuradora durante 1 segundo a evitar o bloqueio do motor da mesma. Desta forma, evitam-se possíveis falhas após períodos de inatividade prolongados.

7. Elementos adicionais de controlo

Depuradora

Iluminação

FUNCIONAMENTO

Ao fechar o contacto inicia-se o funcionamento da depuradora.

PARA

Ao abrir o contacto detém-se o funcionamento da depuradora.

ON

Ao fechar o contacto ligam-se os focos.

OFF

Ao abrir o contacto desligam-se os focos.

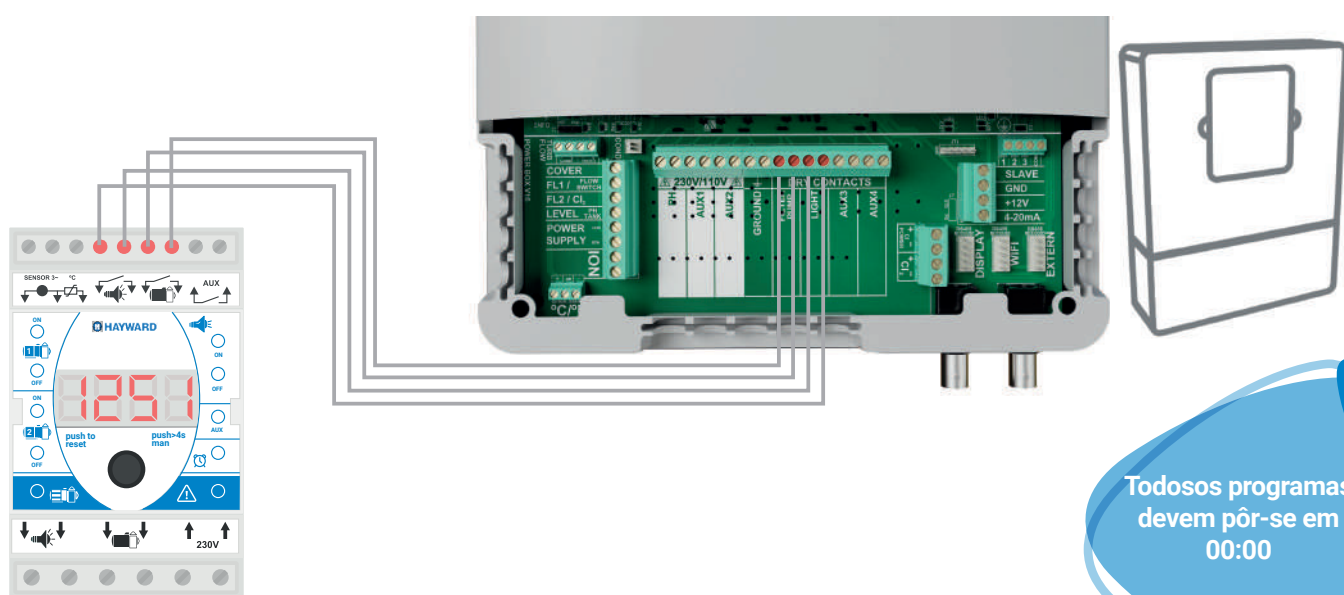

PORTUGUÊS (PT)

Controlo portemperatura

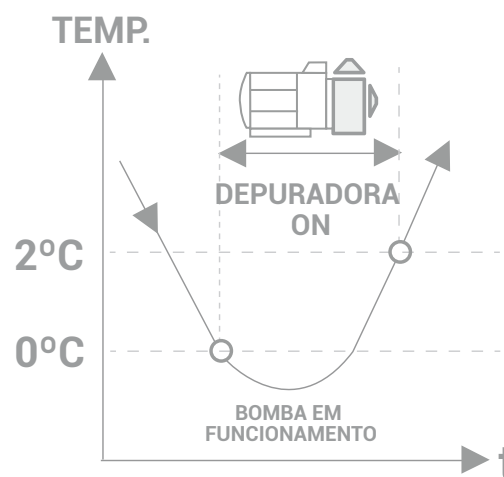
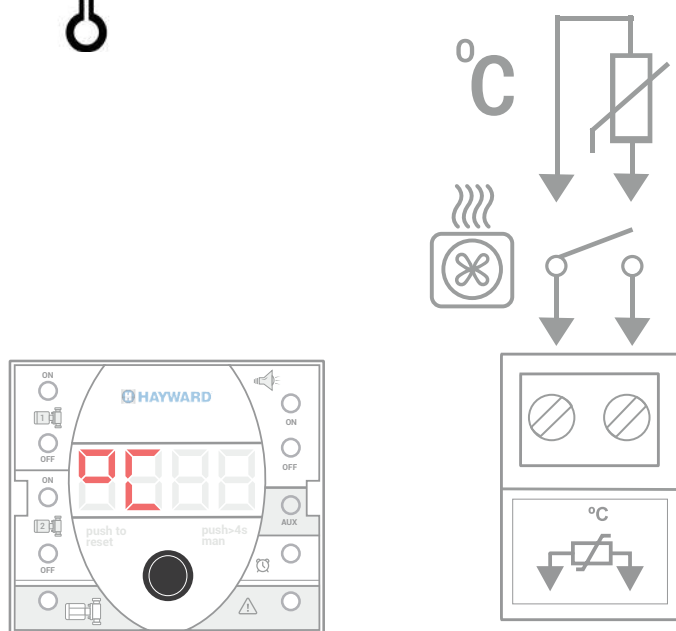

Contacto da bomba de calor. **Quando se ativa** aparece o **símbolo "oC"** no ecrã.

Sonda externa de temperatura ambiente (anti-geadas). Coloca em **funcionamento a depuradora** quando a temperatura ambiente é muito baixa.

○ Contacto auxiliar (AUX)

O contacto do **relé auxiliar** (AUX) é livre de potencial e **ativa-se** ao **mesmo tempo** que a **bombadepuradora**.

Pode utilizar-se em série com a alimentação de bombas doseadoras, cloradores salinos ou quaisquer equipamentos (**250V / 5A máximo**) que devam funcionar ao mesmo tempo que a bomba depuradora.



8. Leitura de Dados

PORTUGUÊS(PT)

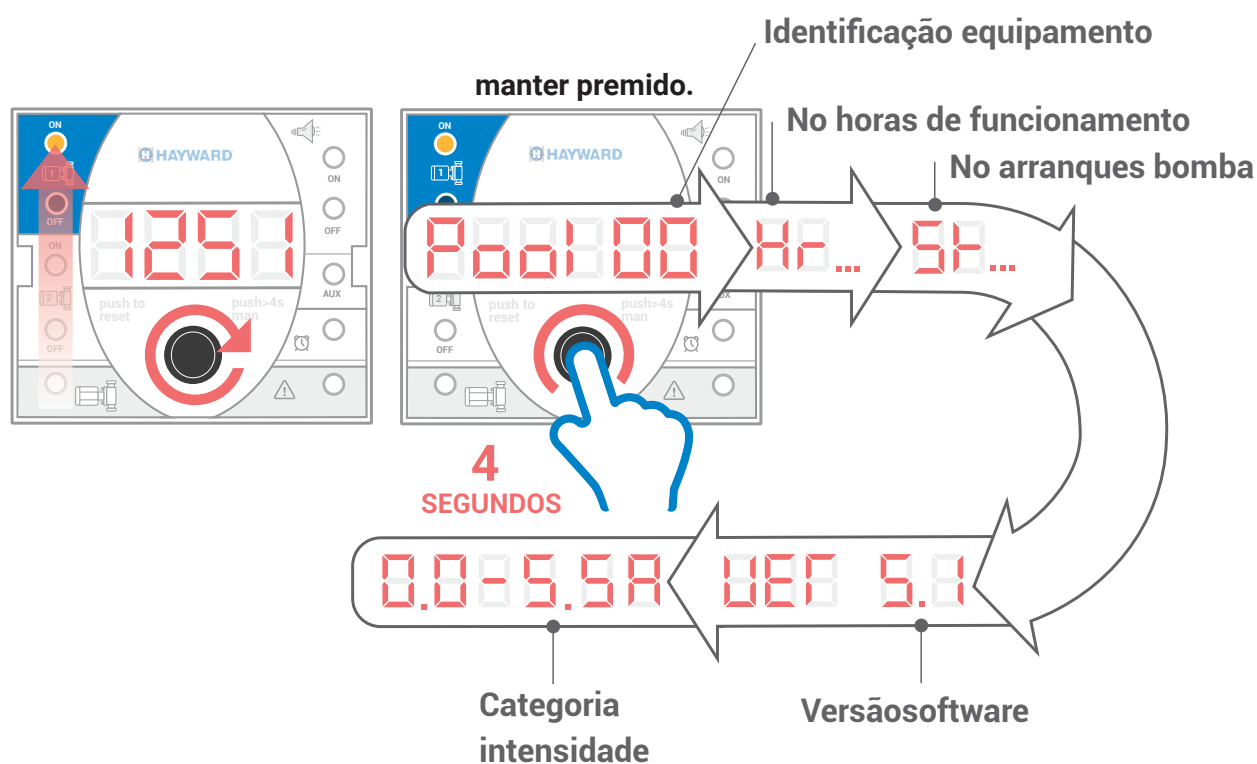

9. Bluetooth(apenas modelo-B)

- 1. Descarregar a App "HAYWARDPOWER".

App android



App iOS



- 2. Abrir App E EMPARELHAR a unidade.

- 3. Interface da aplicação.

Premir

Emparelhar bluetooth

Funcionament o por temperatura

Alarme depurador / reset

Controlo manual depuradora

Controlo manual Iluminação

Mudança cor iluminação

Programação

Depuradora

Programa 1

Programa 2

Iluminação

Programa

Apenas para modelos Bluetooth H-POWER-B

PORTUGUÊS (PT)

00:00:00

09:40 **20:25**

22:00 **02:00**

07:00 **03:00**

ON **OFF** **⌚**

ON **OFF** **⌚**

ON **OFF** **⌚**

RGB **COLOR**

SET

12:24:36

Depuradora

Programa 1

Programa 2

Iluminação

Programa

10. Especificações

Alimentação	230VAC / 400VAC - 50/60Hz
Saída bomba	14A, 230VAC
Saída iluminação (segundo modelo)	230VAC / 5A 12 VAC / 50W 12VAC / 100W 12VAC / 300W
Sinalização	Bomba em funcionamento, Alarme, Programas de filtração, Programa de iluminação, Saída auxiliar e Hora atual
Proteções	Sobrecarga motor, Antibloqueio
Proteção de sobrecarga	20% acima da intensidade medida em calibração
Display LED 4 dígitos	Hora atual, Ajustes e Alarmes
Relé auxiliar	Contacto livredetensão 250V/5A máximo
Secção máxima de terminais	4mm ² (potência) / 2,5mm ² (controlo)
IP/Temperatura	IP65/-10°...+55° C
Software	V.5
Diretivas	- 2016 - D.C. 2014 / 30 / CE EMC D.C. 2014 / 35 / UE C.E. ROHS EN61558 Transformador de focos.
Opções	Interface Bluetooth (-B) Diferencial (-D) Transformador 50W (T50) Transformador 100W (T100) Transformador 300W (T300) Controlo remoto via rádio Sonda externa de temperatura ambiente

PORTUGUÊS(PT)

Referência

HPOW230BDT50

230: Alimentação

400: Alimentação

B: Ligação bluetooth

T50: Transformador 50W

T100: Transformador 100W

T300: Transformador 300W

D: Diferencial

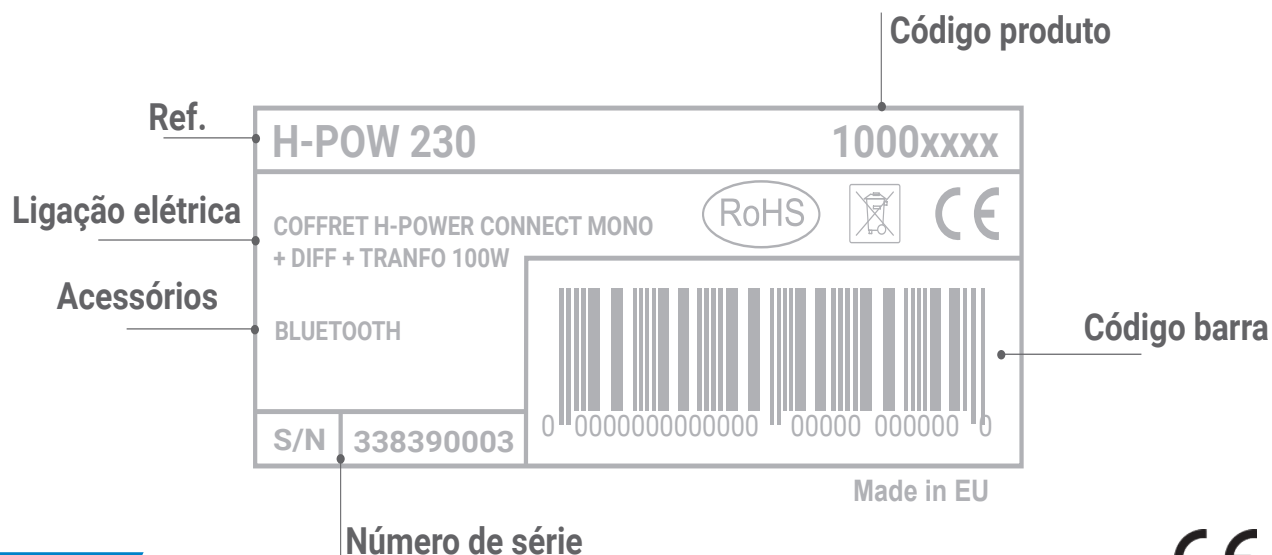

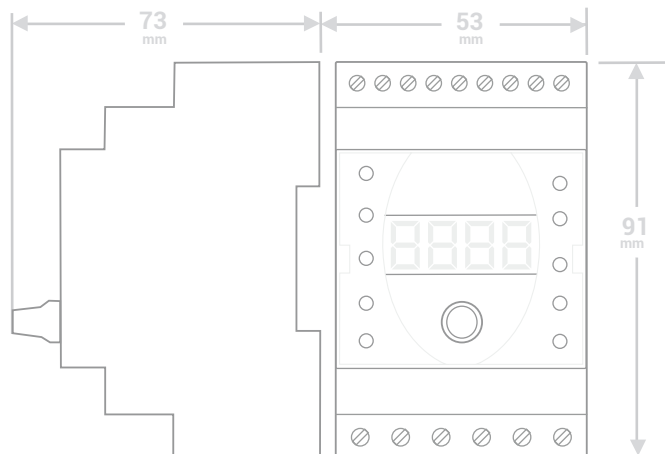
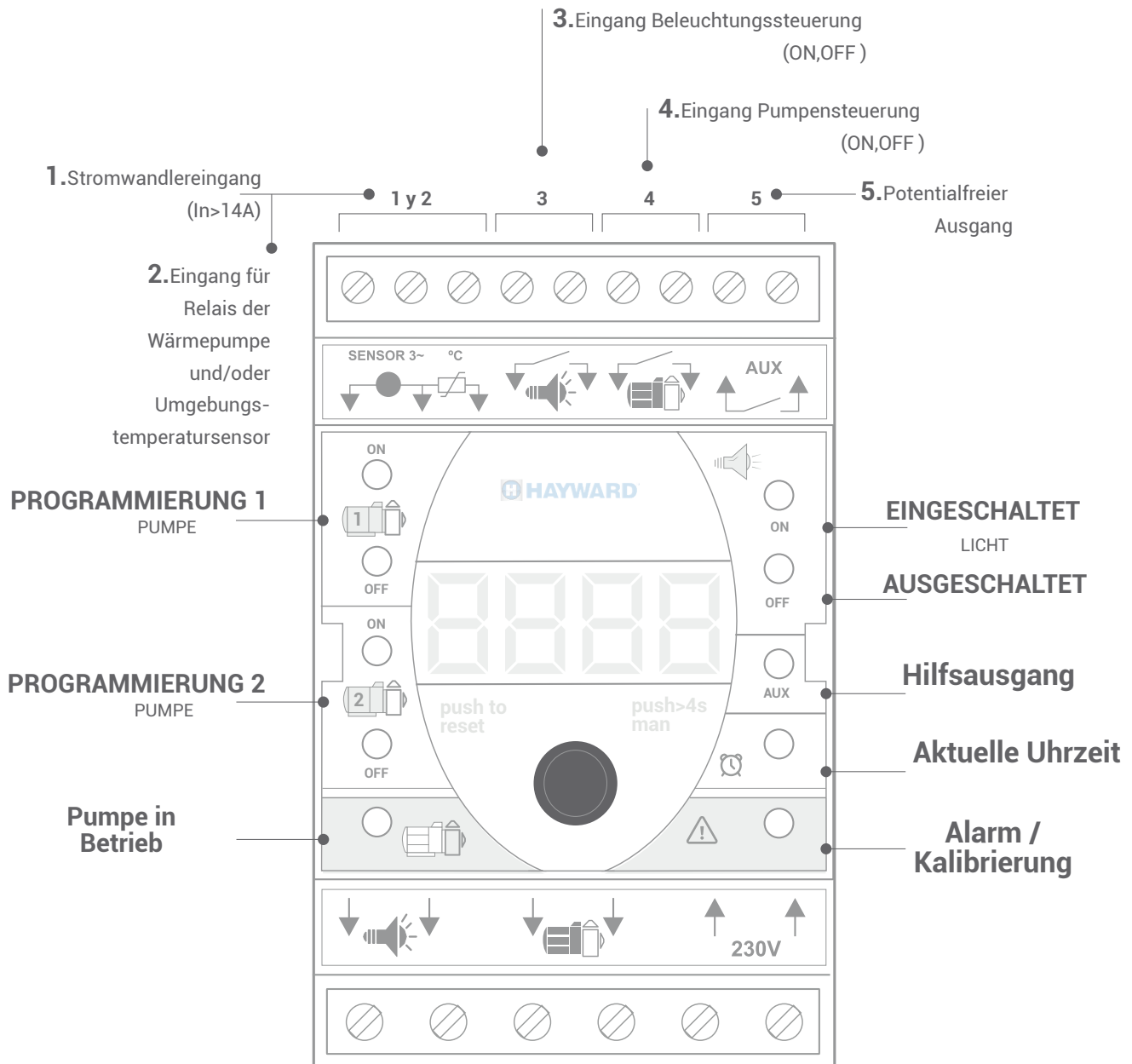

DEUTSCH (DE)

Bluetooth-fähige Modelle synchronisieren sich automatisch mit der Uhrzeit des Smartphone / Tablet

1. Einstellung der Uhrzeit

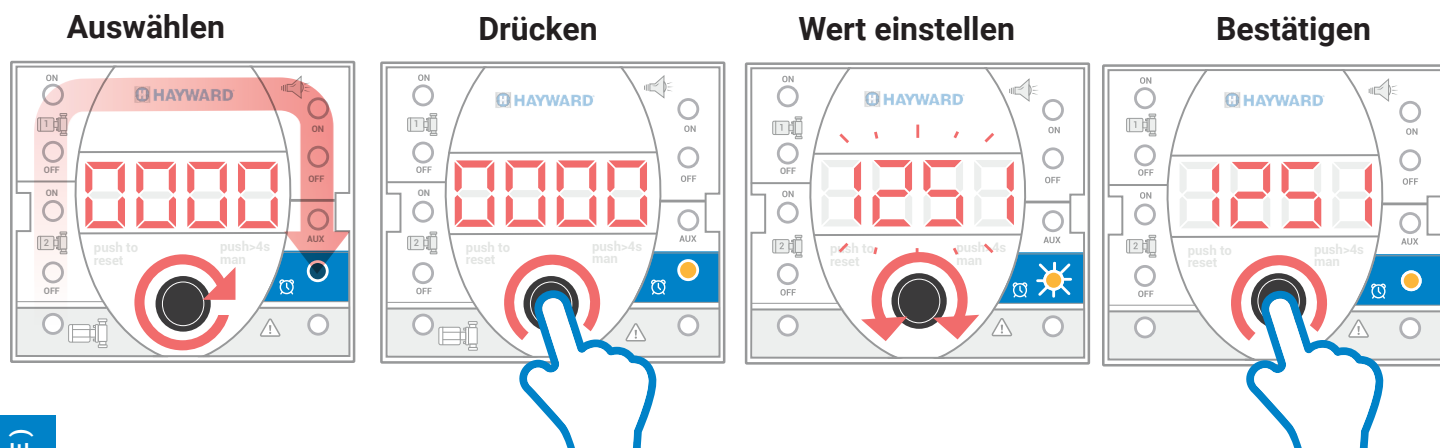

DEUTSCH (DE)

2. Filter- und Beleuchtungsprogramme

LICHTSTATUS

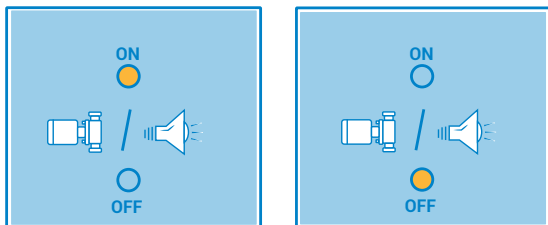

Um ein Programm ZU annullieren wählen Sie die gleiche Uhrzeit bei ON und OFF

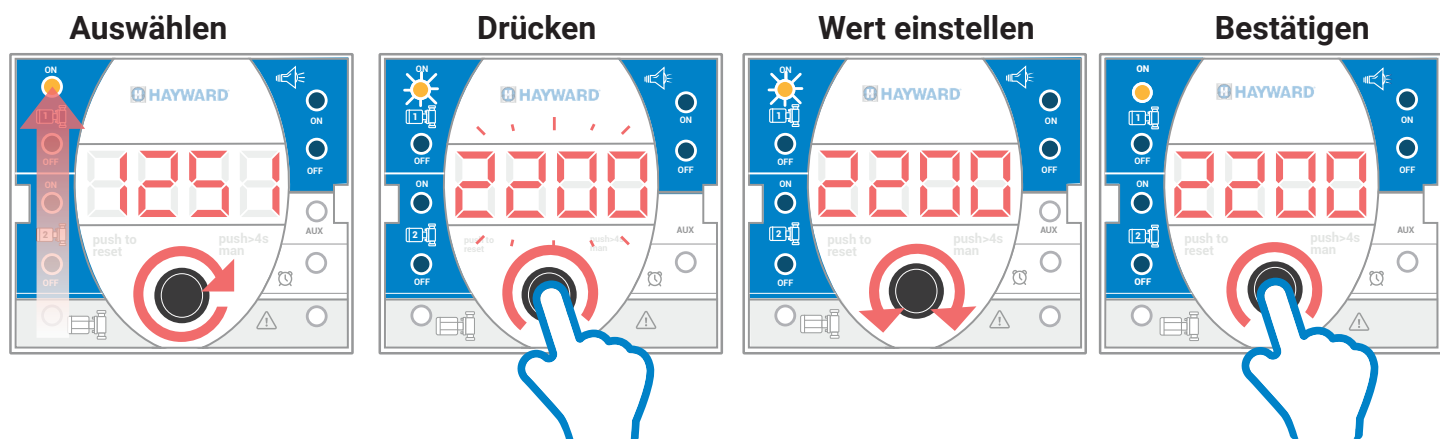

BETRIEB / ANHALTEN DER FILTERUNG

Gedrückt halten

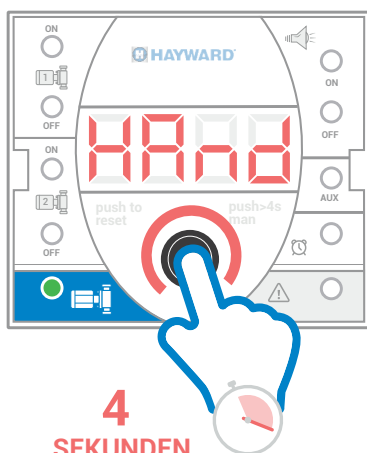

4
SEKUNDEN

START



Länger als 4 Sekunden drücken, um die Pumpe in Betrieb zu setzen.

STOP



Drücken, um die Pumpe anzuhalten.

Drücken

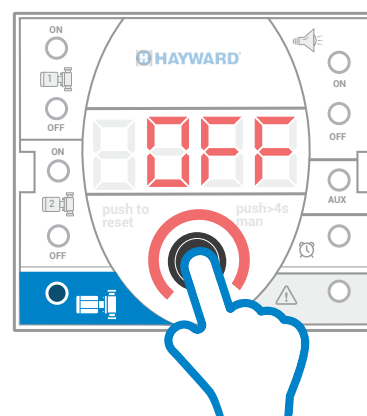

Filter schaltet sich nach Abschluss des nächsten Filterprogramms ab.

Filter schaltet sich zum Beginn des nächsten Filterprogramms ein.

DEUTSCH (DE)

EIN-/AUSSCHALTER DER SCHEINWERFER

Gedrückt halten

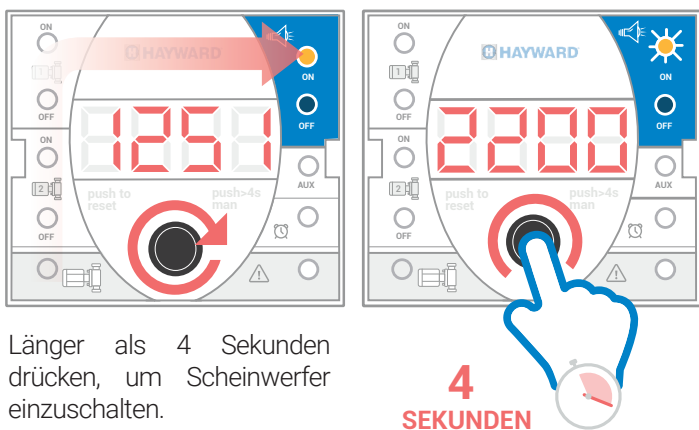

Länger als 4 Sekunden drücken, um Scheinwerfer einzuschalten.

4
SEKUNDEN

Gedrückt halten

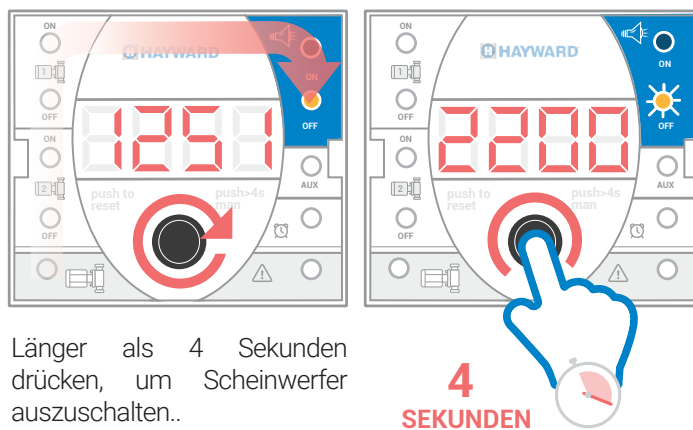

Länger als 4 Sekunden drücken, um Scheinwerfer auszuschalten..

4
SEKUNDEN

Scheinwerfer schalten sich nach 6 Stunden automatisch aus.

Die Scheinwerfer schalten sich zu Beginn des nächsten Beleuchtungsprogramms ein.

6. Schutz der Pumpe

○ Kalibrierung des Pumpenschutzes

Das Gerät stellt sich bei der 1. Inbetriebnahme selbst ein. Wenn Sie eine weitere automatische Kalibrierung durchführen möchten, befolgen Sie die folgenden Schritte:

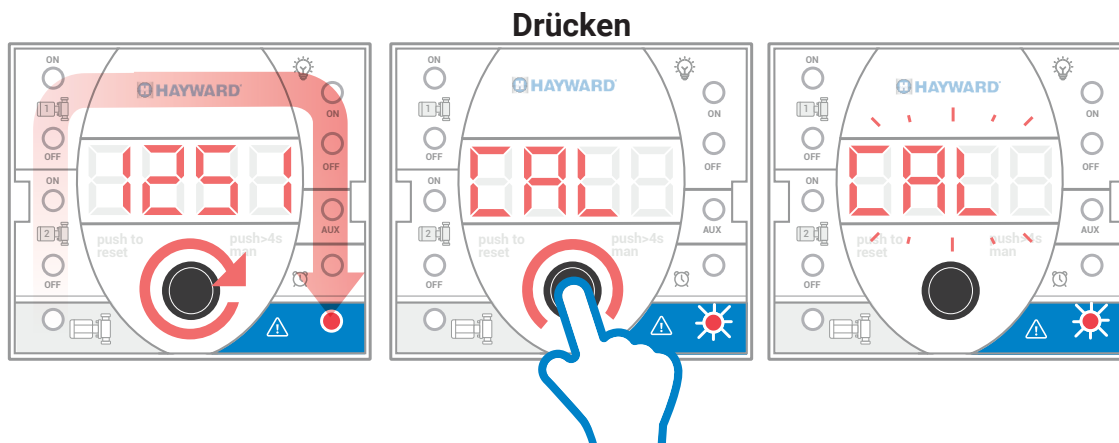

Sobald Sie die Funktion "Kalibrierung" aktiviert wird, stellt die Pumpe sich während der ersten 8 Minuten des Betriebs selbst ein.

DEUTSCH (DE)

Überlastung (overload) und reset

Mögliche Ursachen:

- Pumpe nicht kalibriert.
- Pumpe verstopft.

Im Falle von Überlastung nimmt das Gerät in 60-Sekunden-Intervallen bis zu drei Startversuche vor.

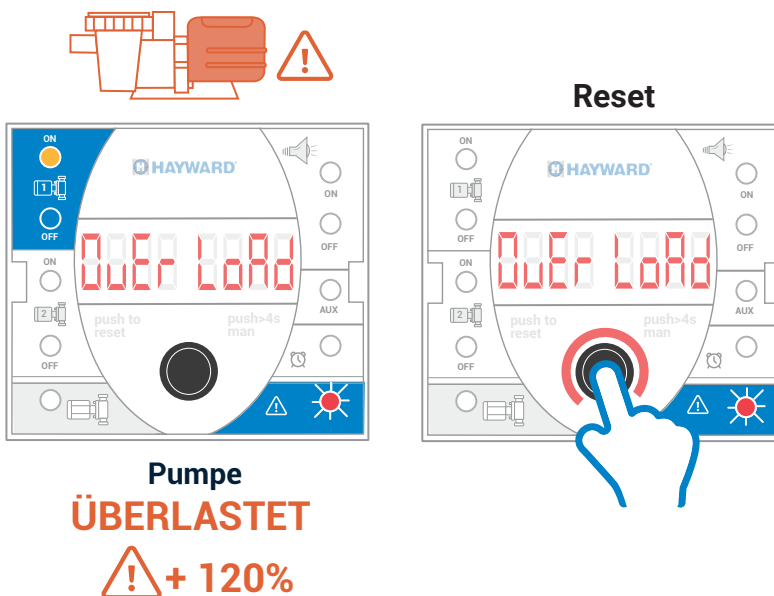

○ System zur Prävention von Rotorblockierung (Blockierschutz)

Alle 23 Stunden betätigt HPOWER die Pumpe 1 Sekunde lang, um zu verhindern, dass sich ihr Motor blockiert. So werden Fehlfunktionen aufgrund von längerer Inaktivität vermieden.

7. Zusätzliche Steuerelemente

Pumpe

BETRIEB

Durch das Schließen des Kontakts wird die Pumpe in Betrieb gesetzt.

STILLSTAND

Durch das Öffnen des Kontakts wird der Betrieb der Pumpe pausiert.

Beleuchtung

ON

Durch das Schließen des Kontakts werden die Scheinwerfer eingeschaltet.

OFF

Durch das Öffnen des Kontakts werden die Scheinwerfer ausgeschaltet.

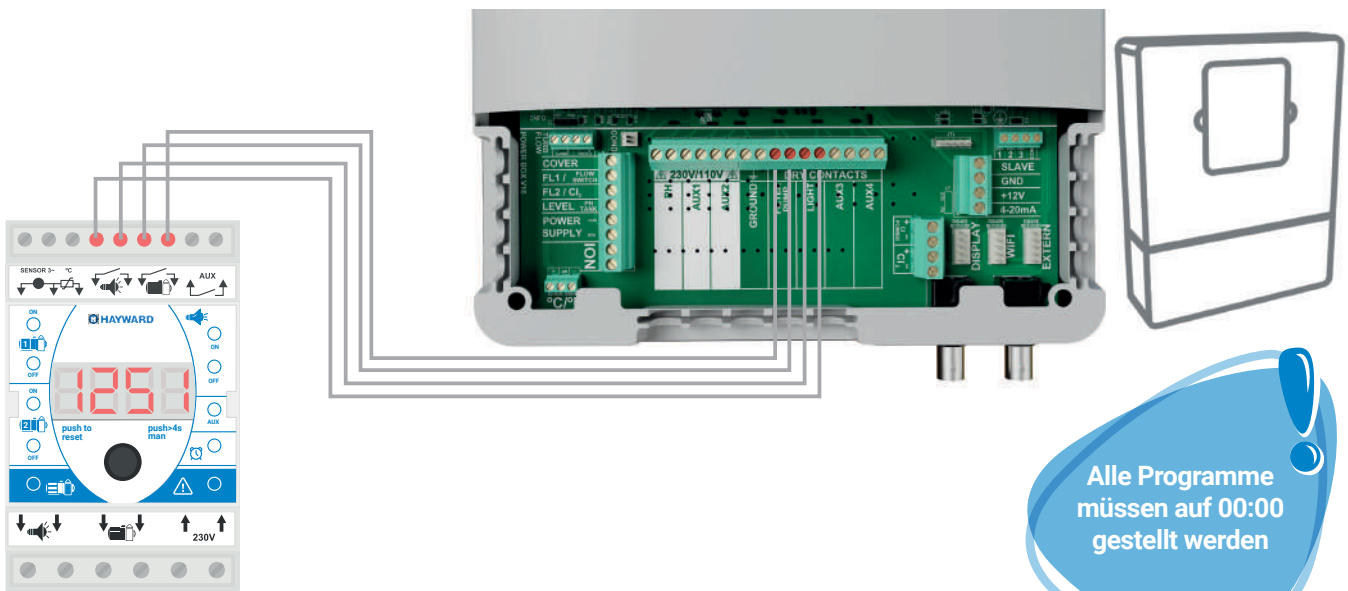

DEUTSCH (DE)

Temperaturkontrolle

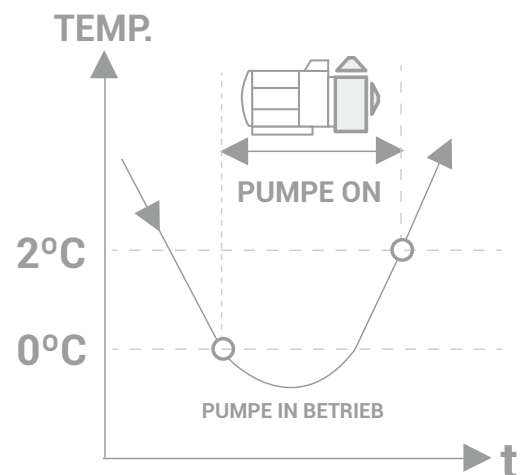
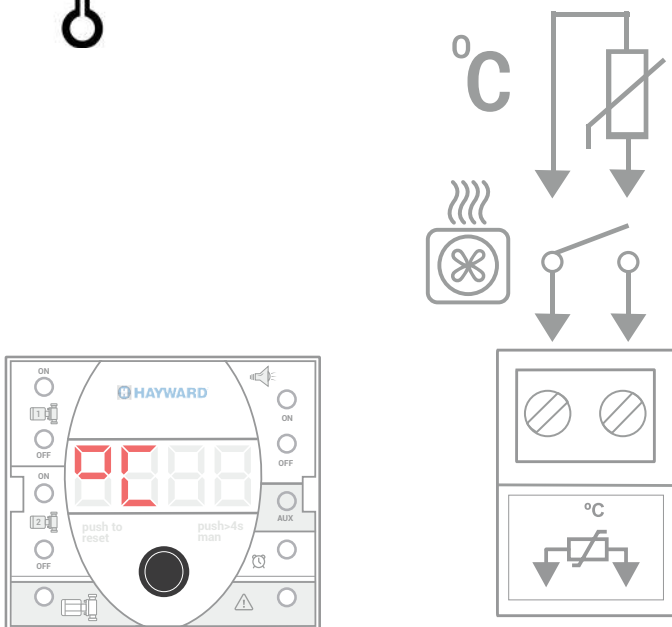

Kontakt der Wärmepumpe. **Wenn sie aktiviert wird**, erscheint das **Symbol "oC"** im Display.

Externer Umgebungstemperatursensor (**Anti-Frost**). Setzt die Pumpe in Betrieb wenn die **Umgebungstemperatur sehr niedrig** ist.

○ Hilfskontakt (AUX)

Der Kontakt des **Hilfsrelais (AUX)** ist potentialfrei und **aktiviert sich zur gleichen Zeit wie die Pumpe.**

Er kann seriell mit der Stromversorgung von Dosierpumpen, Chlorinatoren oder jeglichen Geräten (**max. 250V / 5A**) verwendet werden, die zur gleichen Zeit wie die Reinigungspumpe betrieben werden.



8. Datenauslesung

DEUTSCH (DE)

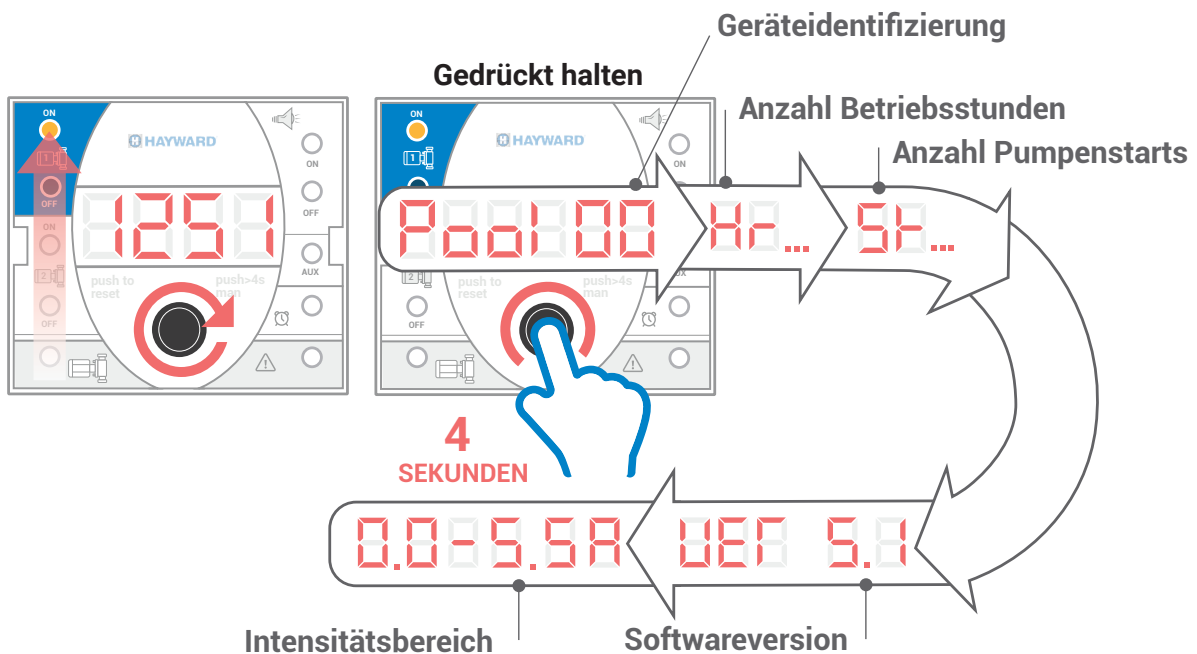

9. Bluetooth (nur Modell-B)

- 1. Herunterladen der App "HAYWARDPOWER".

AndroidApp

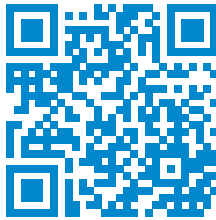

iOSApp

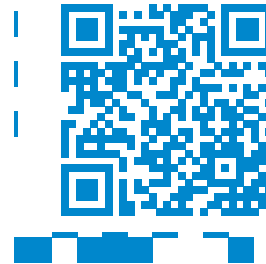

- 2. App öffnen und das Gerät KOPPELN.
- 3. Benutzeroberfläche der App.



Drücken

Mit Bluetooth verbinden

Alarm Pumpe / Reset
Steuerung der Pumpe mit Programm

Steuerung der Beleuchtung mit Programm

Steuerung der Beleuchtung mit Programm

Änderung der Lichtfarbe

Programmierung

Betrieb nach Temperatur

Manuelle Steuerung der

Pumpe Manuelle Steuerung der Beleuchtung

Pumpe

Programm 1

Programm 2

Beleuchtung

Programm

Programm	ON	OFF
1	09:40	20:25
2	22:00	02:00
Beleuchtung	07:00	03:00

DEUTSCH (DE)

10. Spezifikationen

Spannung	230VAC / 400VAC - 50/60Hz
Ausgang Pumpe	14A, 230VAC
Ausgang Beleuchtung (nach Modell)	230VAC / 5A 12 VAC / 50W 12VAC / 100W 12VAC / 300W
Kennzeichnung	Pumpe in Betrieb, Alarm, Filterungs- und Beleuchtungsprogramme, Hilfsausgang und Uhrzeit
Schutz	Motorüberlastung, Blockierschutz
Überlastungsschutz	20% über der bei der Kalibrierung gemessenen Intensität
4-Stellen-LED-Display	Uhrzeit, Einstellungen und Alarmer
Hilfsrelais	Potentialfreier Kontakt max. 250V/5A
Max. Klemmenquerschnitt	4mm ² (Leistung) / 2,5mm ² (Steuerung)
IP/Temperatur	IP65/-10°...+55° C
Software	V.5
Richtlinien	- 2016 - D.C. 2014 / 30 / CE EMC D.C. 2014 / 35 / UE C.E. ROHS EN61558 Scheinwerfertransformator
Optionen	Bluetooth-Schittstelle (-B) Differential (-D) Transformator 50W (T50) Transformator 100W (T100) Transformator 300W (T300) Fernsteuerung per Funk Externer Umgebungstemperatursensor

DEUTSCH (DE)

Referenz

HPOW230BDT50

230: Spannung
400: Spannung
B: Bluetooth-Verbindung
T50: Transformator 50W
T100: Transformator 100W
T300: Transformator 300W
D: Differential

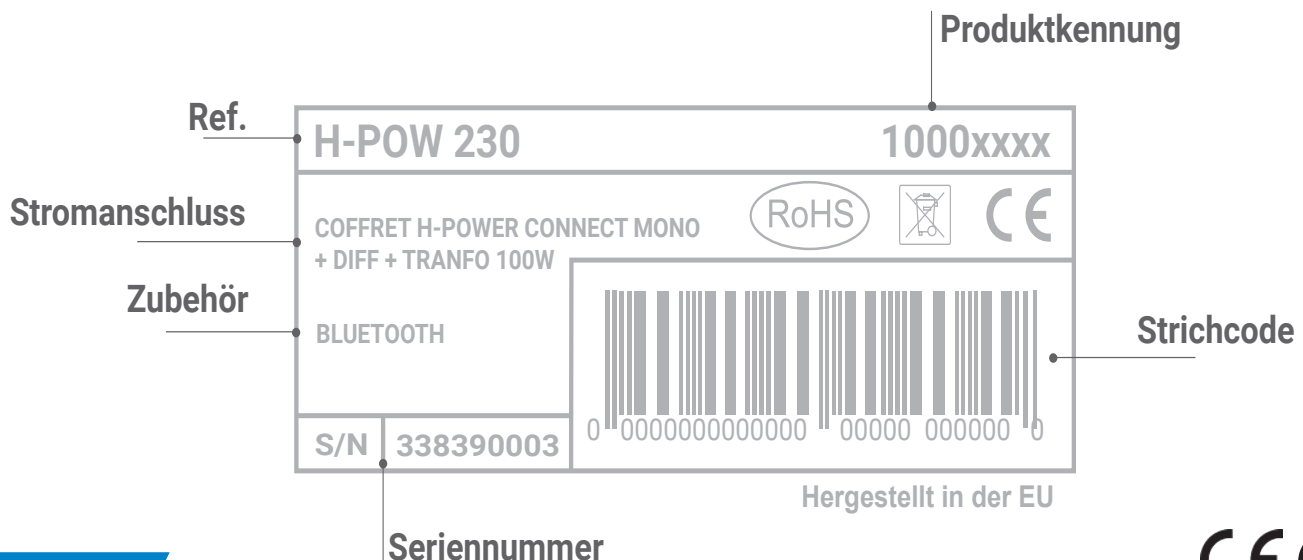

3. Bedieningsmodule/Piloten

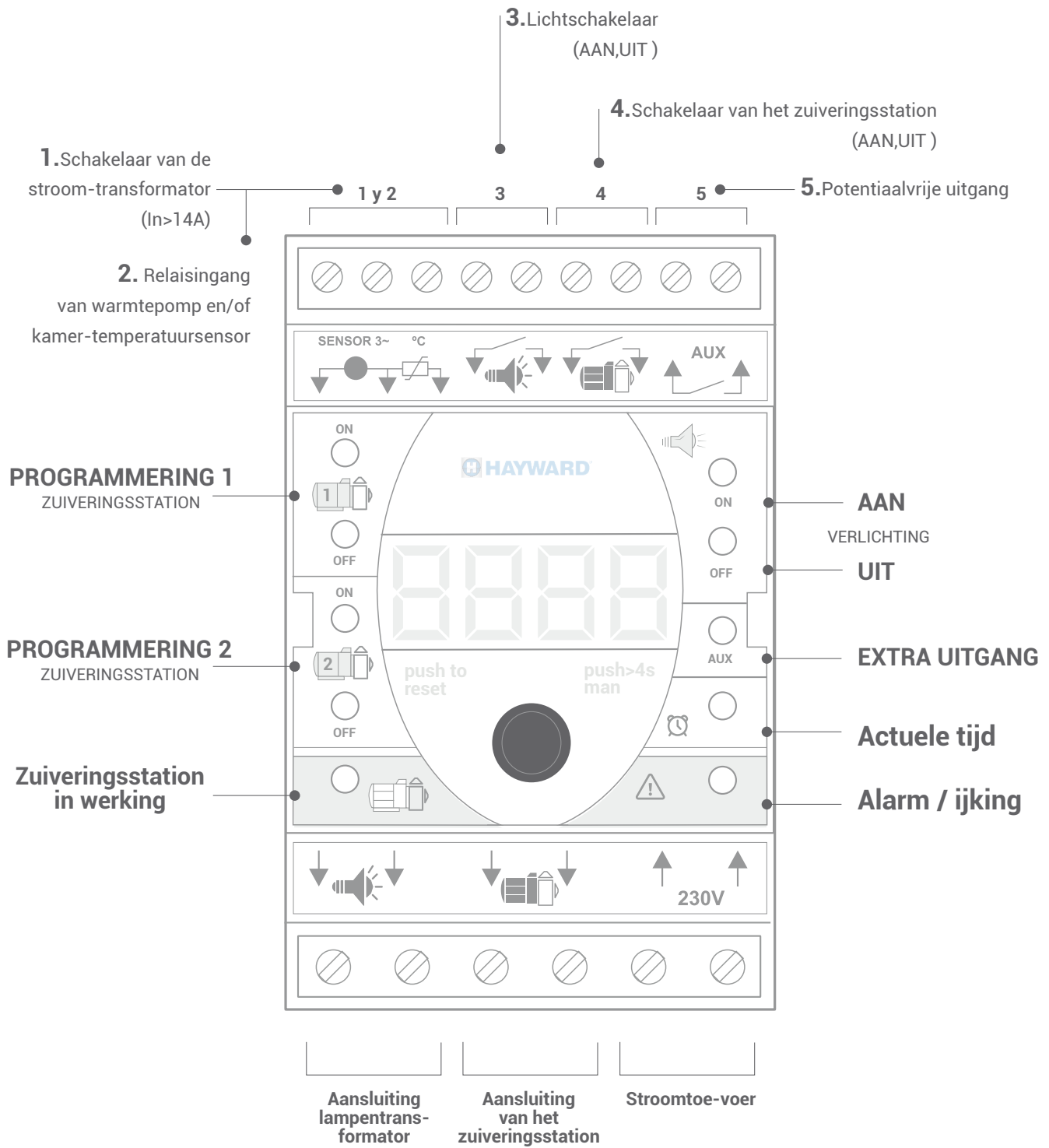

NETHERLAND (NL)

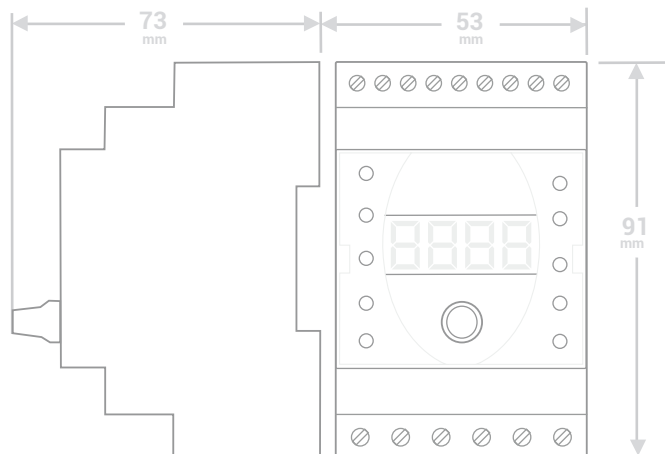

4. Opstarten in 2 stappen

Bluetooth-modellen worden automatisch gesynchroniseerd met de in de smartphone /tablet vermelde tijd

1. Instellen van de actuele tijd

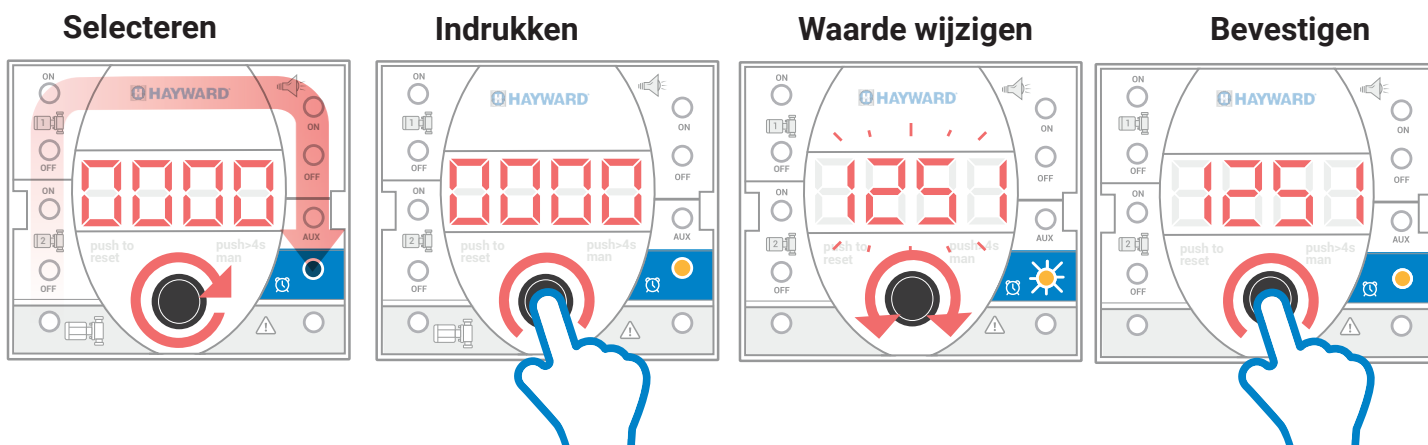

2. Programma's (filtratie en verlichting)

NETHERLAND (NL)

STAAT VAN DE VERLICHTING

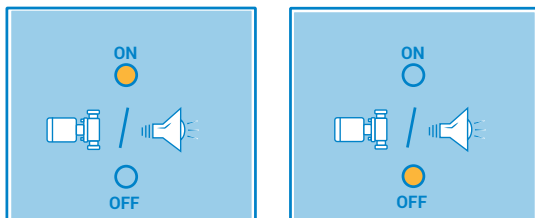

om een programma te annuleren selecteer dezelfde tijd op ON en OFF

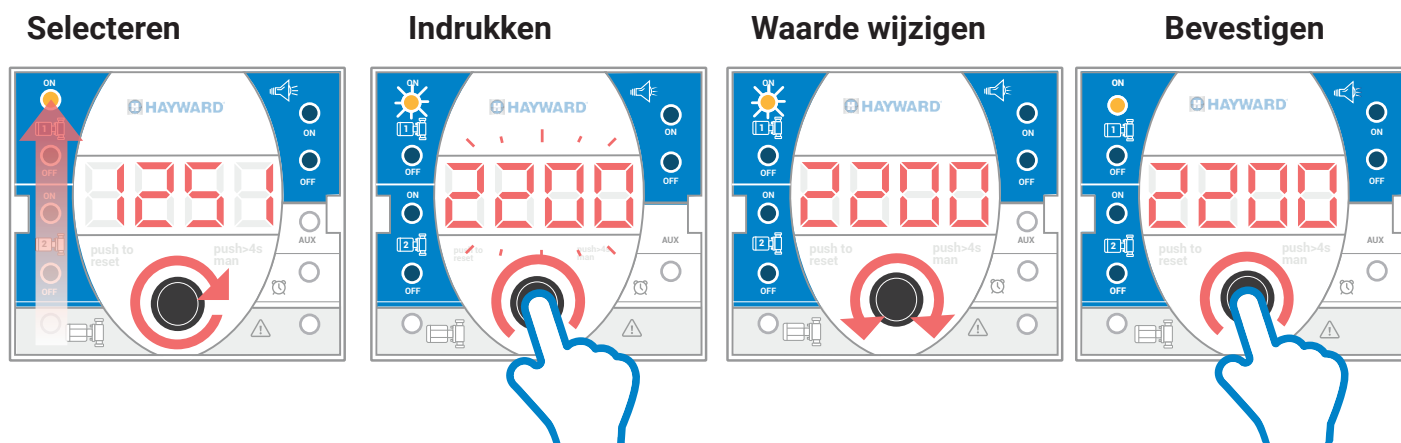

5. Handmatige bediening/Filtratie-verlichting

FILTRATIE AAN/UITZETTEN

Ingedrukt houden

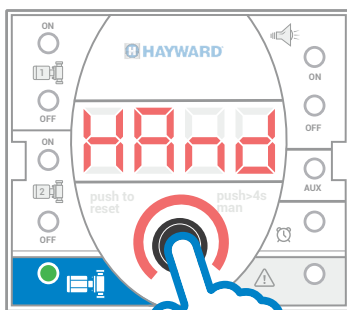

Meer dan 4 seconden ingedrukt houden om het zuiveringsstation aan te zetten.

4
seconden

Gaat vanzelf uit aan het einde van het volgende filtratieprogramma.

Indrukken

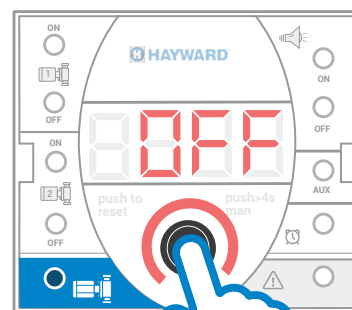

Indrukken om het zuiveringsstation te pauzeren.

Gaat vanzelf aan bij de aanvang van het volgende filtratieprogramma.

LAMPEN AAN/UITZETTEN

Ingedrukt houden

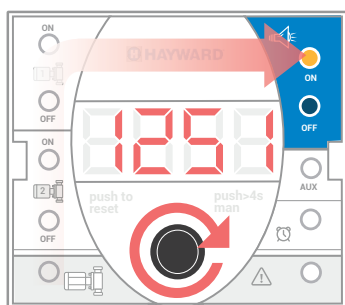

Meer dan 4 seconden ingedrukt houden om de lampen aan te zetten.

4
seconden.

Gaan na 6 uur vanzelf uit.

Ingedrukt houden

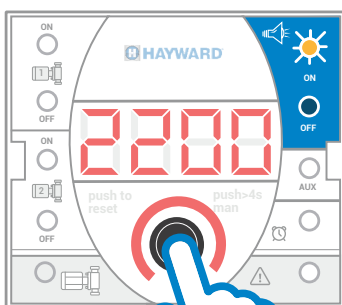

Meer dan 4 seconden ingedrukt houden om de lampen uit te zetten.

4
seconden

de aanvang van het volgende verlichtingsprogramma.

6. Bescherming zuiveringsstation

○ IJking van de pompbescherming

Het apparaat wordt automatisch geijkt bij de eerste keer opstarten. Als u een automatische ijking wilt uitvoeren, graag de volgende stappen opvolgen:

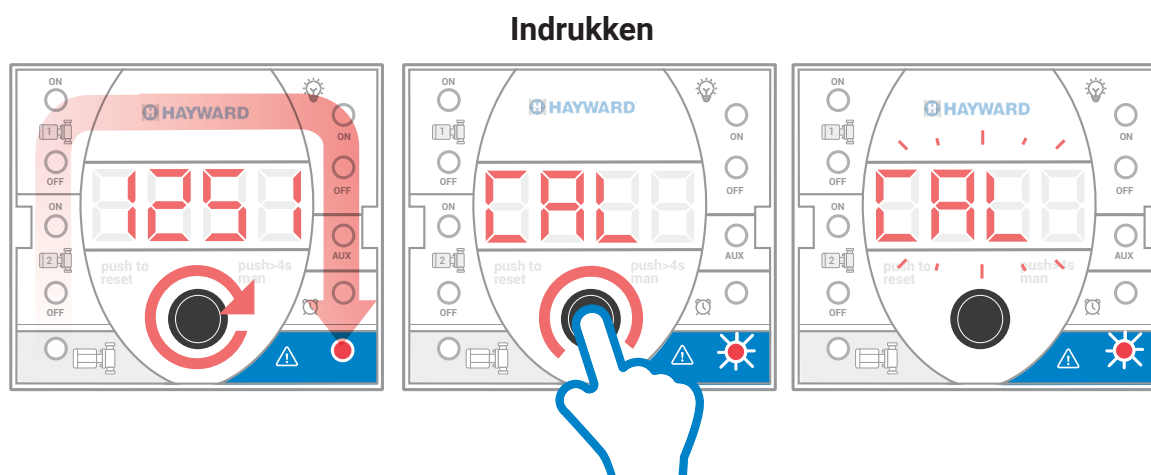

Zodra de ijking is bevestigd, wordt de pomp automatisch geijkt tijdens de eerste 8 minuten na opstarten.

○ Overbelasting (overload) en reset

Mogelijke oorzaken:

- Pomp niet geijkt.
- Pomp geblokkeerd.

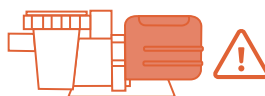

Reset

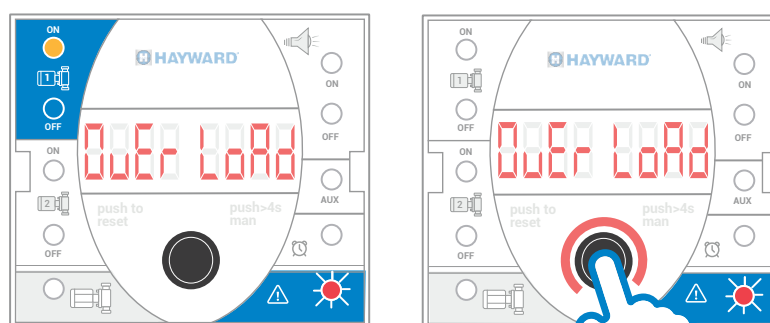

**Pomp
OVERBELAST
 + 120%**

○ Preventief systeem ter blokkering van de rotor (deblokkeerbescherming)

Elke 23 uur zet HPOWER gedurende 1 seconde het zuiveringsstation aan om zo het blokkeren van de motor ervan te voorkomen. Zo worden eventuele storingen of haperingen, na lange tijd niet gebruikt te zijn, vermeden.

Bij overbelasting worden maximaal drie pogingen gedaan met een interval van 60 seconden voor het opstarten

7. Extra Bedieningselementen

Zuiveringsstation



AAN

Bij het sluiten van het contact wordt het zuiveringsstation aangezet.



UIT

Bij het openen van het contact wordt het zuiveringsstation gepauzeerd.

Verlichting

ON

Bij het sluiten van het contact gaan de lampen aan.

OFF

Bij het openen van het contact gaan de lampen uit.

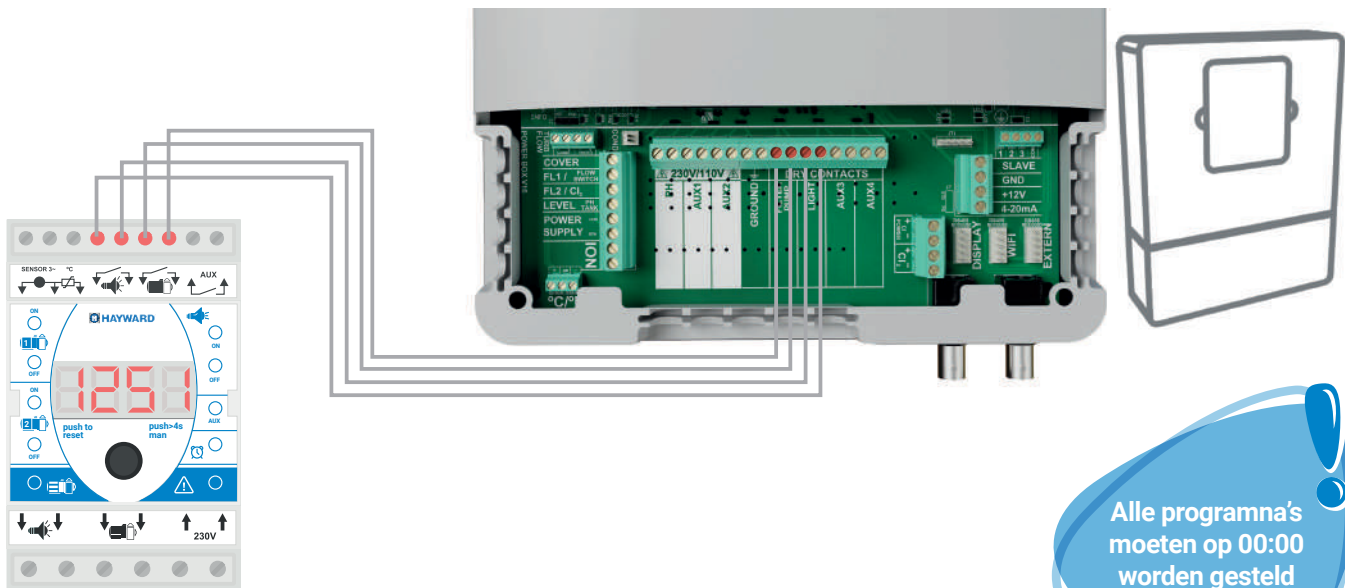

Alle programma's moeten op 00:00 worden gesteld

NETHERLAND (NL)

Temperatuurscontrole

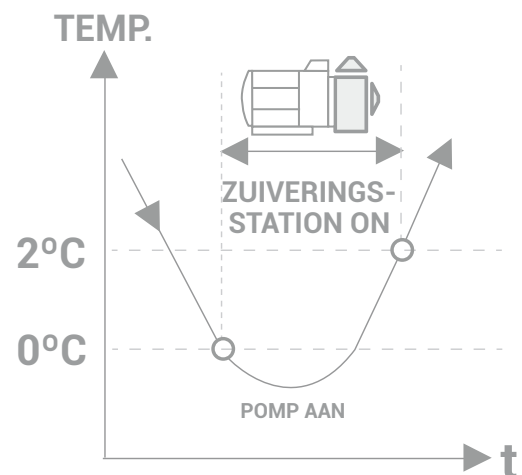
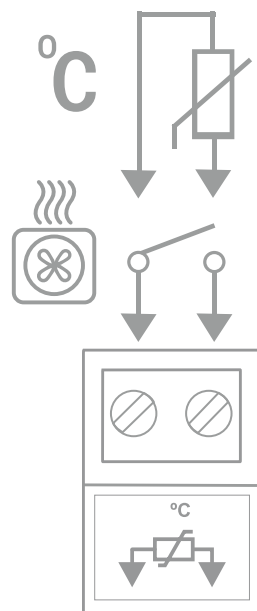

Contact van de warmtepomp. Bij het aanzetten verschijnt het symbool "oC" op het scherm.

Externe omgevingstemperatuursensor (anti-vries). Hierdoor wordt het zuiveringsstation aangezet als de omgevingstemperatuur heel laag is.

Extra contact (AUX)

Het extra relaiscontact (AUX) is potentiaalvrij en wordt aangezet op hetzelfde moment als de zuiveringspomp.

Kan in serie worden geschakeld met de voeding van doseerpompen, zoutwaterchlorinatoren of elk apparaat (250V / 5A maximaal) dat tegelijkertijd met de zuiveringspomp in werking is.



8. Het lezen van de gegevens

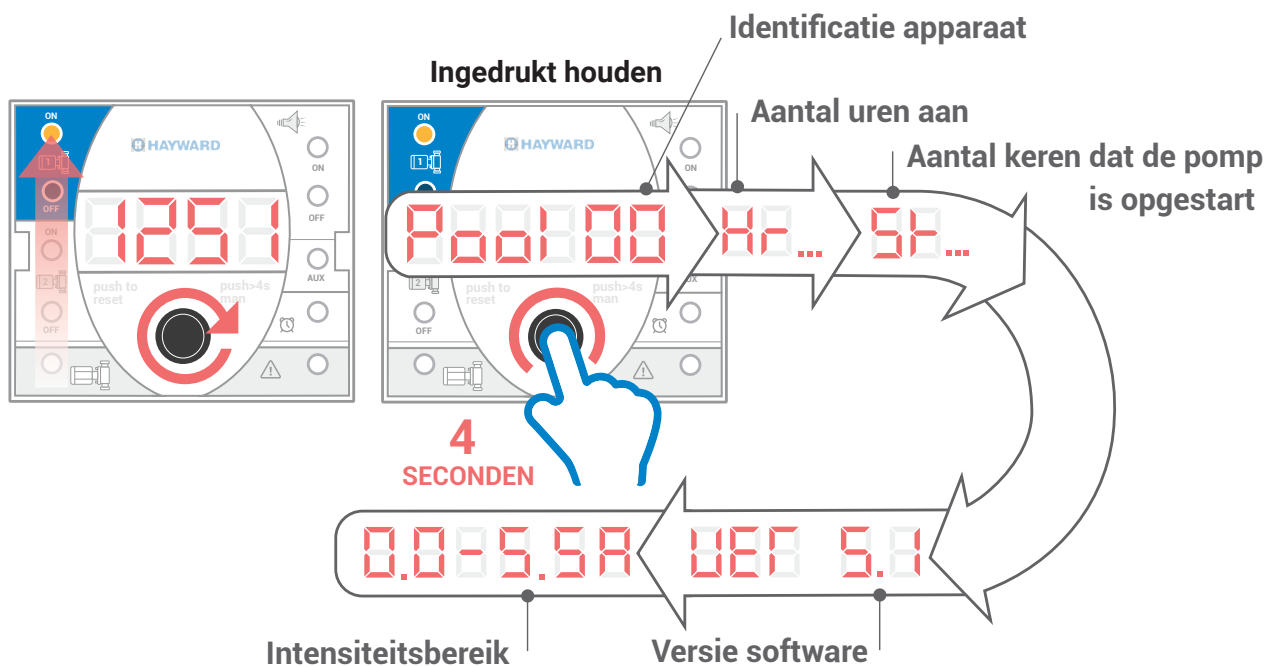

9. Bluetooth(alleen model - B)

- 1. De App "HAYWARDPOWER" downloaden.

App android

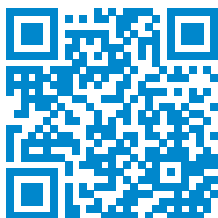

App iOS

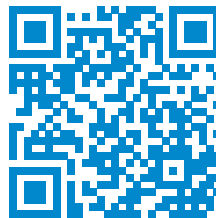

- 2. App openen en het apparaat koppelen.

- 3. Interface van de applicatie.



Drukken (points to the Bluetooth icon in the top right corner)

bluetooth koppelen (points to the Bluetooth icon in the top right corner)

Bedrijf door temperatuur (points to the temperature icon)

Alarm zuiveringsstation / reset (points to the alarm icon)

Bediening zuiveringsstation metprogramma (points to the ON/OFF/CLOCK buttons for the first station)

Handmatige bediening zuiveringsstation (points to the ON/OFF/CLOCK buttons for the first station)

Handmatige bediening verlichting (points to the ON/OFF/CLOCK buttons for the light)

Bediening zuiveringsstation metprogramma (points to the ON/OFF/CLOCK buttons for the second station)

Kleur van de verlichting wijzigen (points to the RGB and COLOR buttons)

Programmering (points to the SET button)

Zuiveringsstation (points to the station icon)

Programma 1 (points to the first program row)

Programma 2 (points to the second program row)

Verlichting (points to the light icon)

Programma (points to the light program row)

Programma	ON	OFF
Programma 1	09:40	20:25
Programma 2	22:00	02:00
Verlichting	07:00	03:00

NETHERLAND (NL)

10. Especificaties

Voeding	230VAC / 400VAC - 50/60Hz
Uitgang pomp	14A, 230VAC
Uitgang verlichting (naargelang model)	230VAC / 5A 12 VAC / 50W 12VAC / 100W 12VAC / 300W
Signalering	Pomp aan, Alarm, Filtratatieprogramma's, verlichtingsprogramma's, extra uitgang en actuele tijd
Beschermingen	Overbelasting motor, deblokking
Overbelastingsbescherming	20% bovenop de bij de ijking gemeten intensiteit
Display LED 4 cijfers	Actuele tijd, Instellingen en Alarmen
Extra relais	Contactzonder spanning 250V/5A maximaal
Max. doorsnee terminals	4mm ² (potentieel) / 2,5mm ² (controle)
IP/Temperatuur	IP65/-10°...+55° C
Software	V.5
Richtlijnen	- 2016 - D.C. 2014 / 30 / CE EMC D.C. 2014 / 35 / UE C.E. ROHS EN61558 Transformator voor de lampen.
Opties	Bluetooth-interface (-B) Diferentiaal (-D) Transformator 50W (T50) Transformator 100W (T100) Transformator 300W (T300) Afstandsbediening via radio Externe omgevingstemperatuursensor

Referentie

HPOW230BDT50

230: Voeding

400: Voeding

B: Bluetooth-
verbinding

T50: Transformator 50W

T100: Transformator 100W

T300: Transformator 300W

D: Diferentiaal

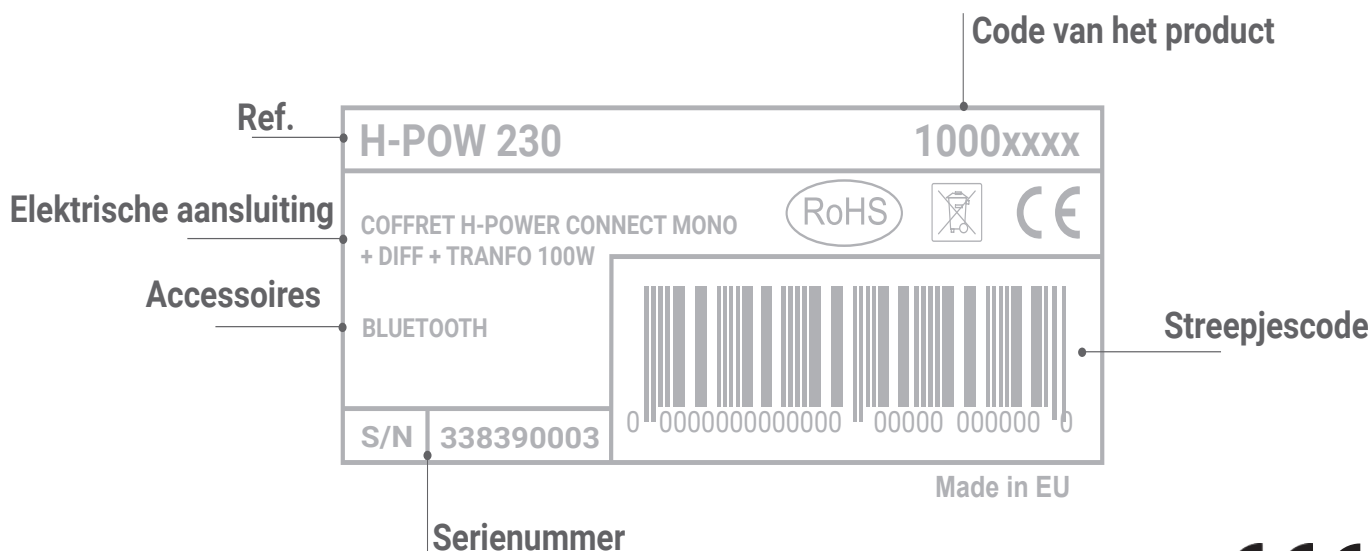

3. Modulo di controllo / Spie

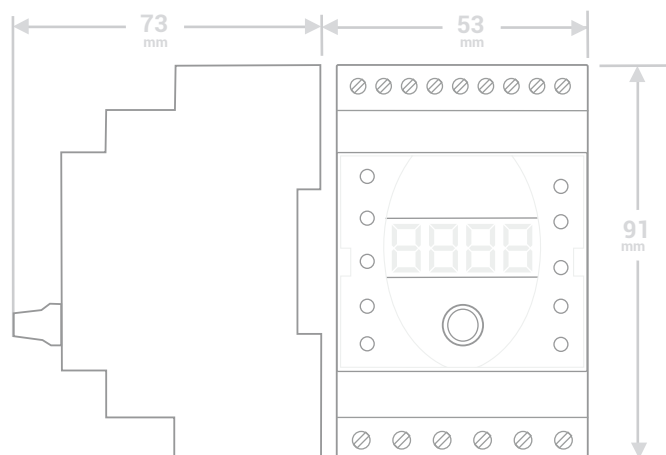
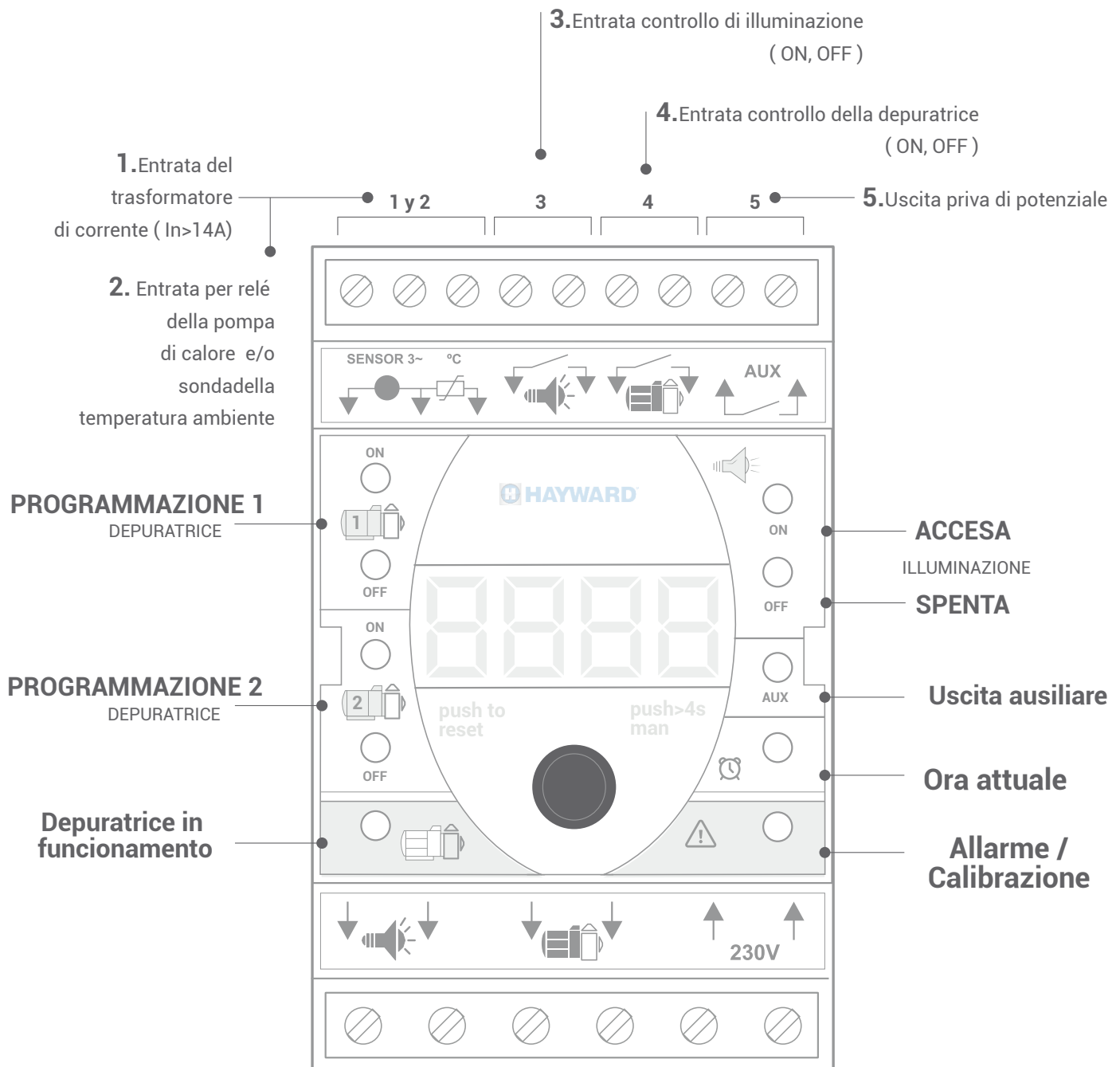

ITALIANO (IT)

I modelli con Bluetooth
si sincronizzano automaticamente
con l'ora dello Smartphone / Tablet

1. Regolazione dell'ora attuale

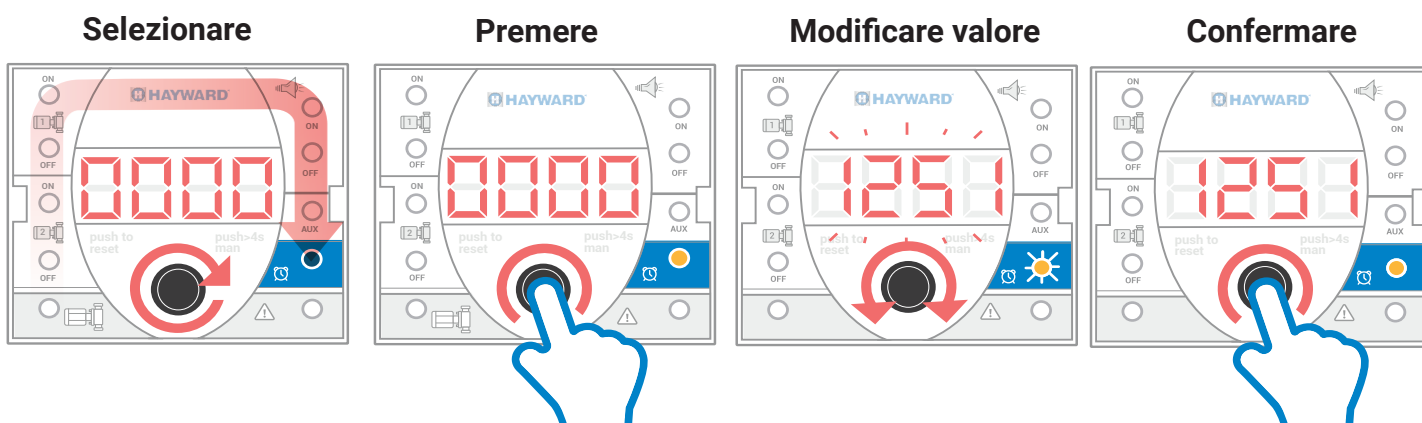

2. Programmi di filtraggio e illuminazione

STATI LUCI

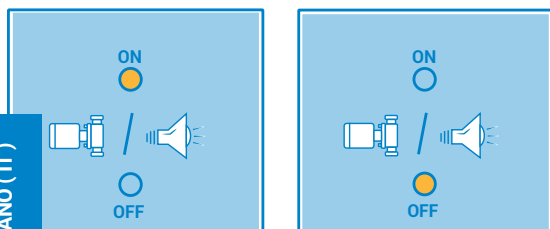

Per annullare un programma
selezionare la stessa ora in
ON e in OFF

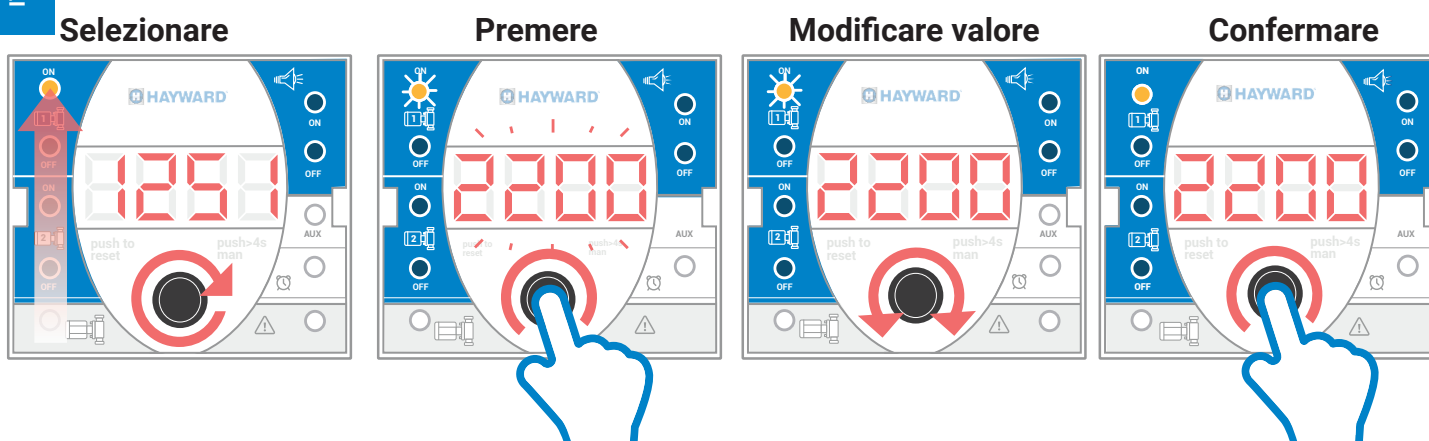

5. Controllo MANUALE / Filtraggio-Illuminazione

1. AVVIAMENTO / ARRESTO DEL FILTRAGGIO

Mantenere premuto



4
SECONDI



Premere per più di 4 secondi per avviare la depuratrice.

Si spegnerà alla fine del seguente programma di filtraggio.

Premere

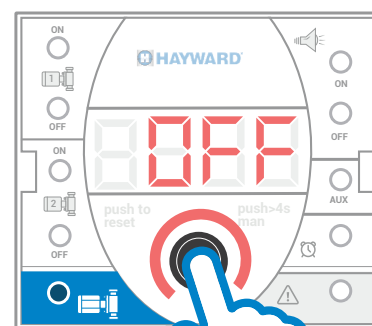

Premere per mettere in pausa la depuratrice.

Si accenderà all'inizio del seguente programma di filtraggio.

ACCENSIONE / SPEGNIMENTO LUCI

Mantenere premuto



Premere per più di 4 secondi per accendere le luci.

4
SECONDI

Si spegneranno automaticamente dopo 6 ore.

Mantenere premuto



Premere per più di 4 secondi per spegnere le luci.

4
SECONDI

Si accenderanno all'inizio del seguente programma di illuminazione.

ITALIANO (IT)

6. Protezione depuratrice

● Calibrazione della protezione della pompa

Il dispositivo si regola da solo con il 1° avviamento. Se si desidera effettuare una nuova calibrazione automatica, seguire i passi indicati qui sotto:

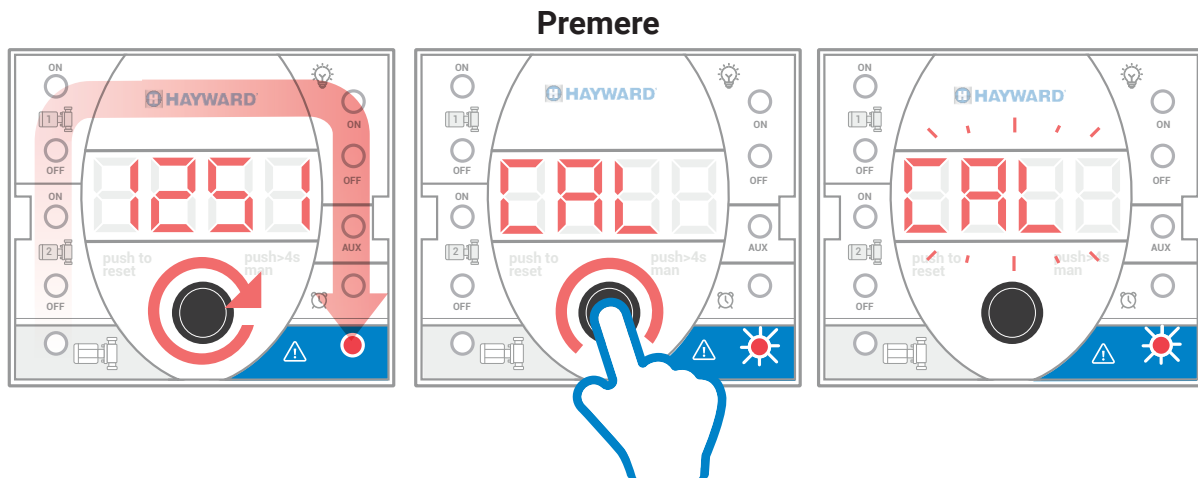

Una volta confermata la funzione "calibrazione", la pompa si regolerà da sola nei primi 8 minuti di funzionamento.

● Sovraccarico (Overload) and reset

Possibili cause:

- Pompa non calibrata
- Pompa bloccata.

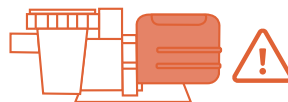

ITALIANO (IT)

In caso di sovraccarico il dispositivo realizza fino a tre tentativi con un intervallo di 60 secondi di avvio



Pompa SOVRACCARICA

 + 120%

Reset

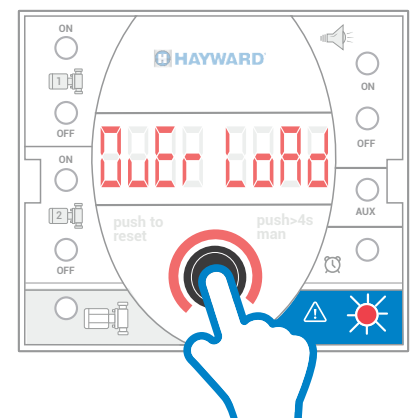

● Sistema preventivo di blocco rotore (protezione anti-blocco)

Ogni 23 ore HPOWER azionerà la depuratrice per 1 secondo evitando il blocco del motore della stessa. In questo modo si evitano possibili errori dopo lunghi periodi di inattività.

7. Elementi aggiuntivi di controllo

Depuratrice

AVVIAMENTO

Quando si chiude il contatto si avvia la depuratrice.

ARRESTO

Aprendo il contatto si mette in pausa la depuratrice.

Illuminazione

ON

Chiudendo il contatto si accendono le luci.

OFF

Aprendo il contatto si spengono le luci.

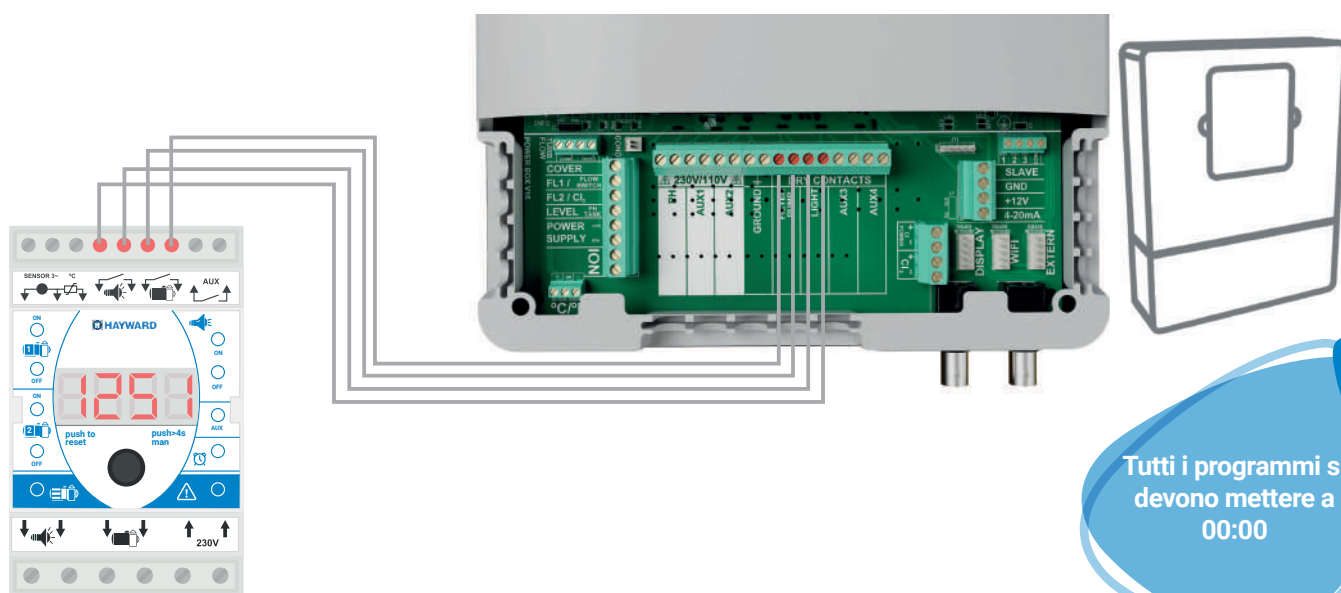

Controllo tramite temperatura

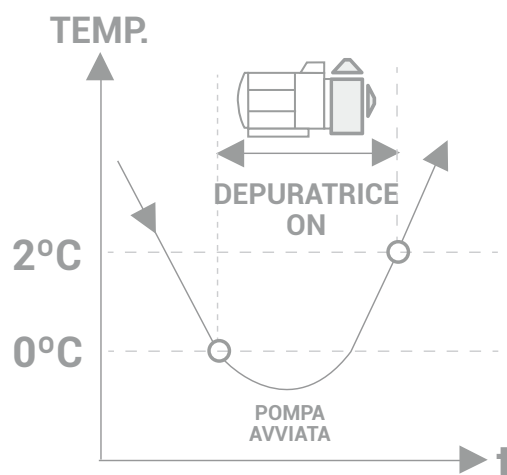
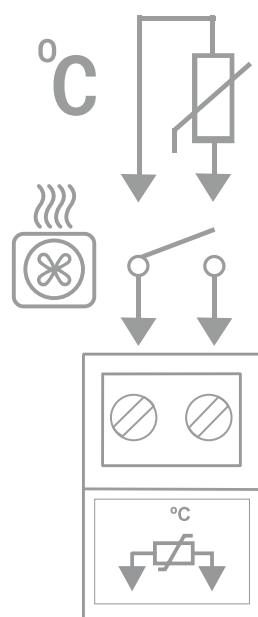
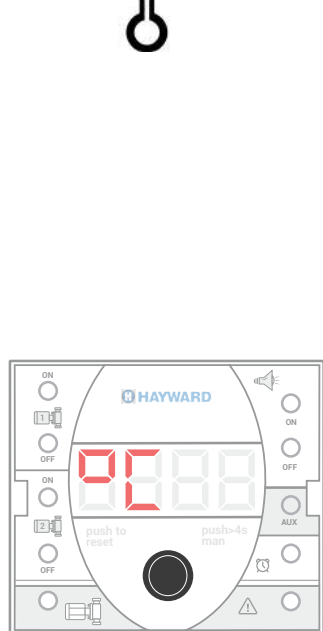

Contatto della pompa di calore. **Quando si attiva** appare il **simbolo "°C"** sullo schermo.

Sonda esterna di temperatura ambiente (antigelo). Mette in **moto la depuratrice** quando la **temperatura ambiente è molto bassa**.

Contatto ausiliare

Il contatto del **relé ausiliare (AUX)** é privo di potenziale e si **attiva contemporaneamente** alla **pompa depuratrice**.

Si può utilizzare in serie con l'alimentazione di pompe dosatrici, cloratori salini o qualsiasi dispositivo (**250V/5A max**) che debba funzionare al tempo stesso della pompa depuratrice.

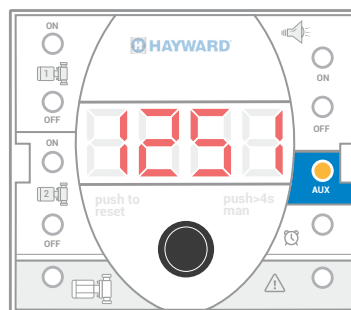

8. Lettura di Dati

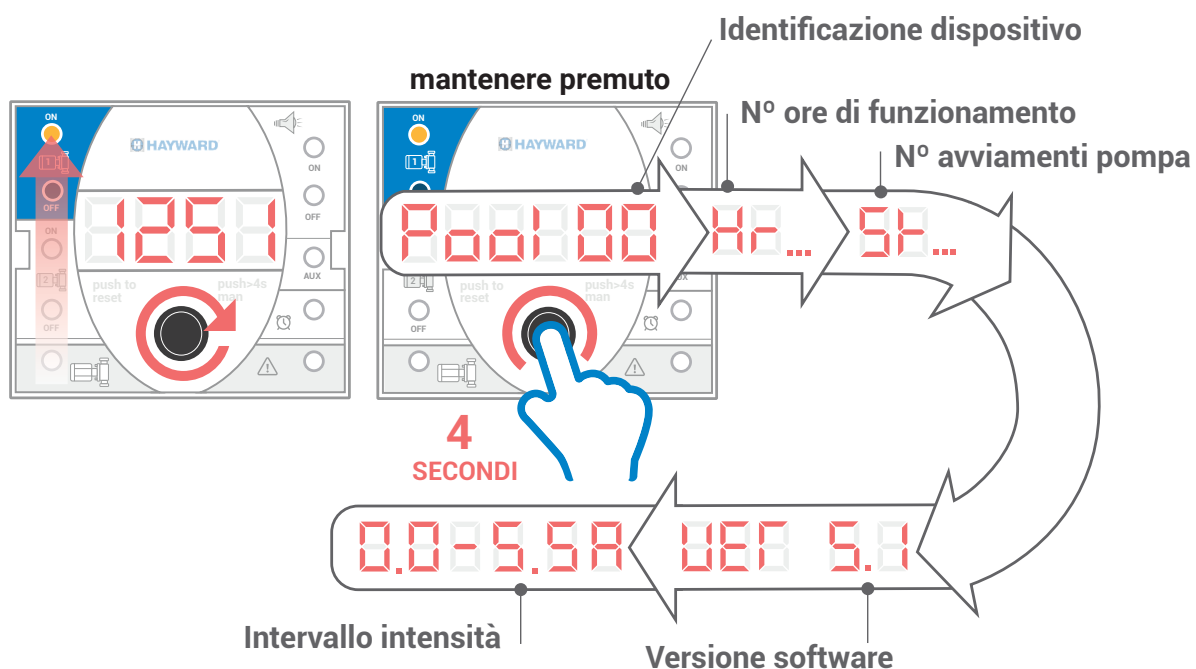

9. Bluetooth (solo modello - B)

- 1. Scaricare la App "HAYWARD POWER".

App android

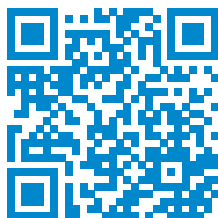

App iOS



- 2. Aprire App e ABBINARE l'unità.

- 3. Interfaccia applicazione.

Premere

Solo per modelli
Bluetooth
H-POWER - B

Funzionament
o per
temperatura

Abbinare bluetooth

Allarme depuratrice / reset

Controllo depuratrice
con programma

Controllo
manuale
depuratrice

Controllo depuratrice
con programma

Controllo
manuale
Illuminazione

Controllo illuminazione con programma

Programmazione

ITALIANO (IT)

Depuratrice

Programma 1

Programma 2

Illuminazione

Programma

10. Especifiche

Alimentazione	230VAC / 400VAC - 50/60Hz
Uscita pompa	14A, single-phase models 230VAC
Uscita illuminazione (in base al modello)	230VAC / 5A 12 VAC / 50W 12VAC / 100W 12VAC / 300W
Segnaletica	Pompa in funzionamento, Allarme, Programmi di filtraggio, Programma di illuminazione, Uscita ausiliare e Ora attuale
Protezioni	Sovraccarico motore, Anti-blocco
Protezione da sovraccarico	20% al di sopra dell'intensità misurata in calibrazione
Display LED 4 cifre	Ora attuale, Regolazioni e Allarmi
Relè ausiliare	Free-voltage contact 250V / 5A
Sezione massima morsetti	4mm ² (power) / 2.5mm ² (control)
IP/Temperatura	IP65/-10°...+55° C
Software	V.5
Direttive	- 2016 - D.C. 2014 / 30 / CE EMC D.C. 2014 / 35 / UE C.E. ROHS EN61558 Trasformatore luci
Opzioni	Interfaccia Bluetooth (-B) Differenziale (-D) Trasformatore 50W (T50) Trasformatore 100W (T100) Trasformatore 300W (T300) Telecomando via radio

Riferimento

HPOW230BDT50

230: Alimentazione
400: Alimentazione
B: Connessione bluetooth
T50: Trasformatore 50W
T100: Trasformatore 100W
T300: Trasformatore 300W
D: Differenziale

ITALIANO (IT)

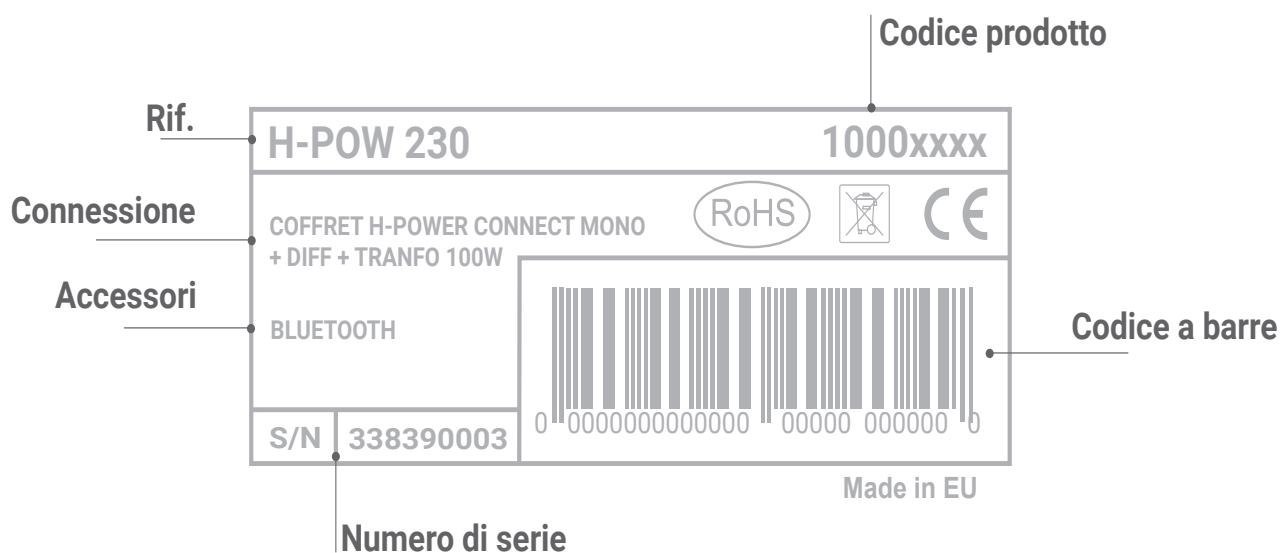

3. Модули управления / Пилотные указатели

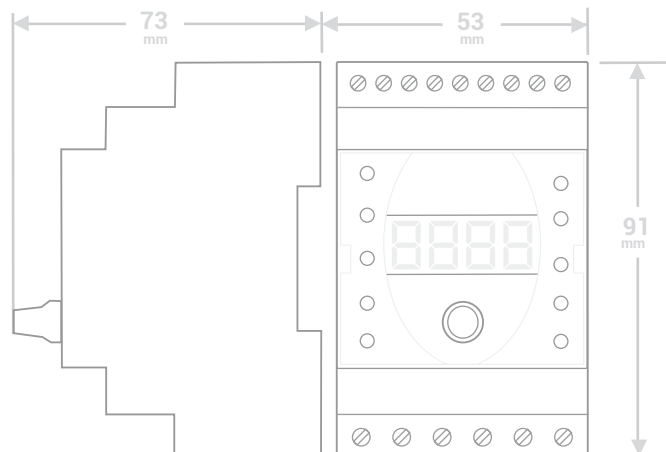
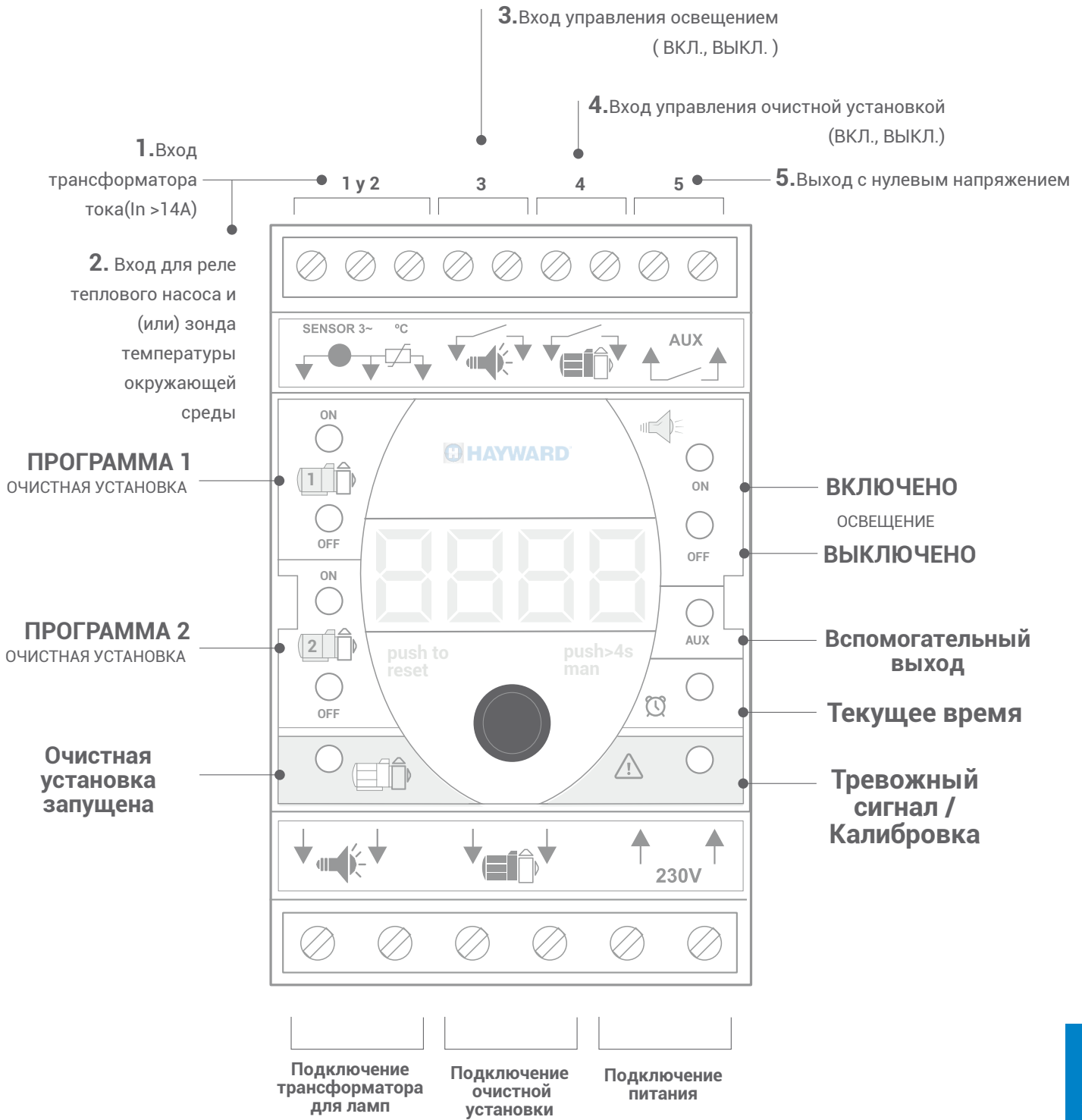

Модели с Bluetooth
синхронизируются
автоматически со временем
смартфона / планшета

1. Настройка текущего времени

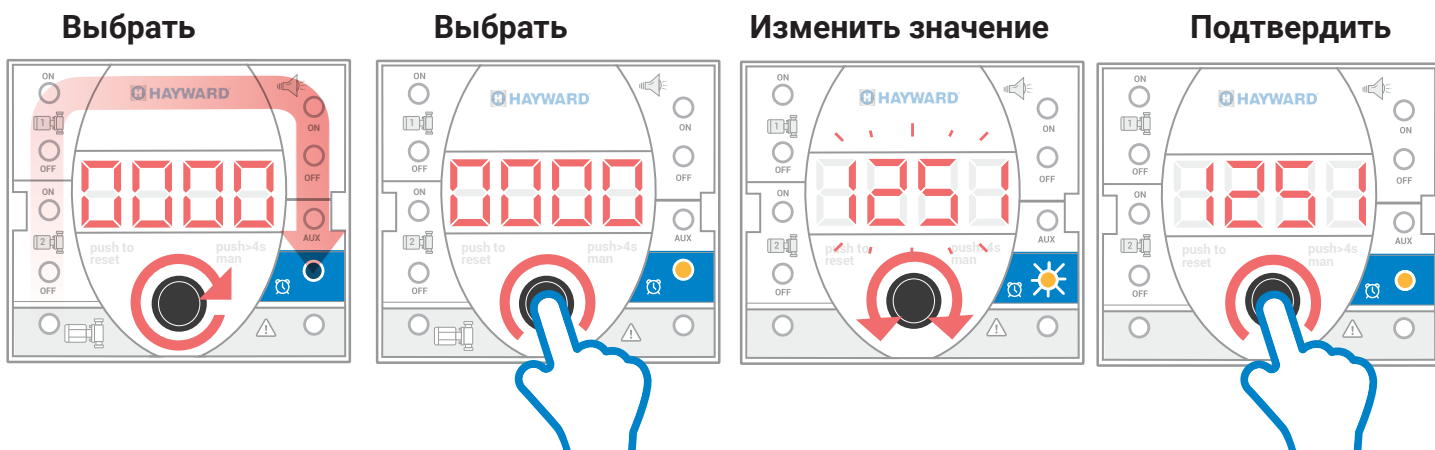

2. Программы фильтрации и освещения

СОСТОЯНИЕ ОСВЕЩЕНИЯ

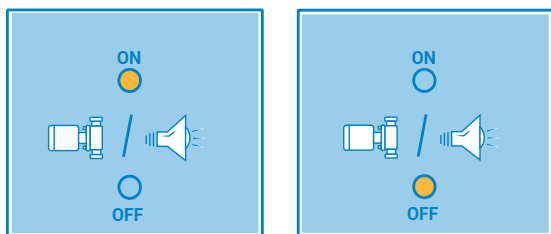

Чтобы аннулировать программу,
выберите то же время во ВКЛ. И ВЫКЛ.

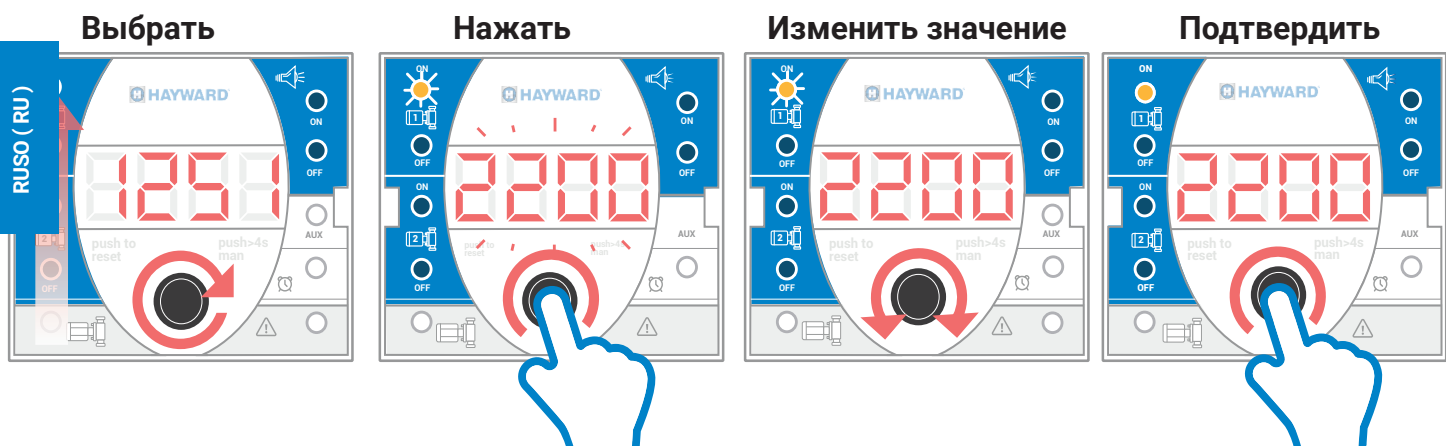

○ ЗАПУСК / ОСТАНОВКА ФИЛЬТРОВАНИЯ

Нажать и удерживать

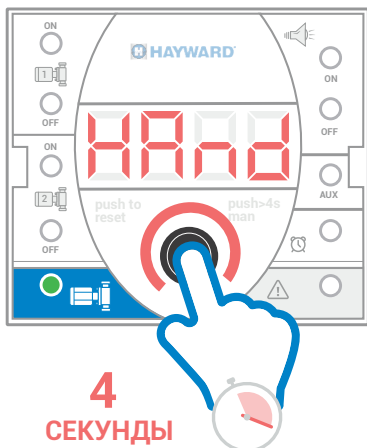

Нажать и удерживать более 4 секунд, чтобы запустить очистную установку.

Погаснет по окончании следующей программы фильтрации.

Нажать

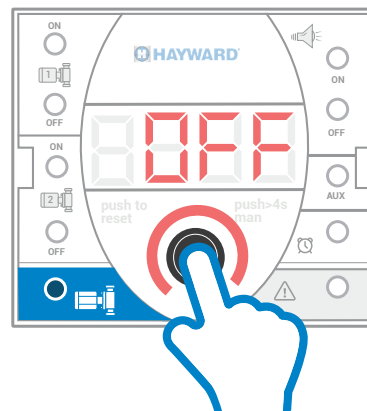

Нажать, чтобы поставить очистную установку на паузу.

Загорится в начале следующей программы фильтрации.

○ ВКЛЮЧЕНИЕ / ВЫКЛЮЧЕНИЕ ЛАМП

Нажать и удерживать

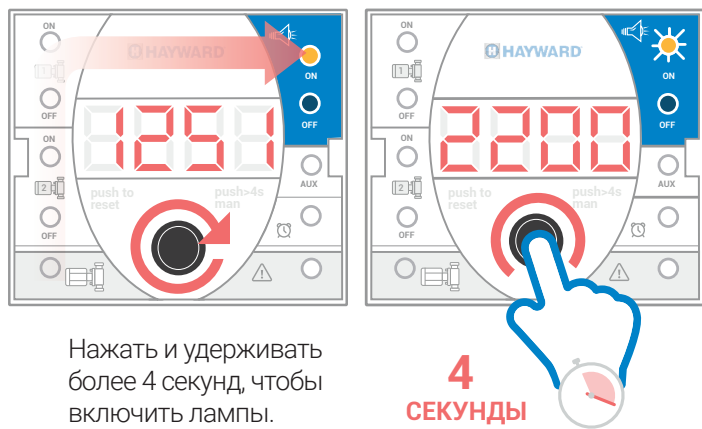

Нажать и удерживать более 4 секунд, чтобы включить лампы.

Выключаются автоматически через 6 часов

Нажать и удерживать

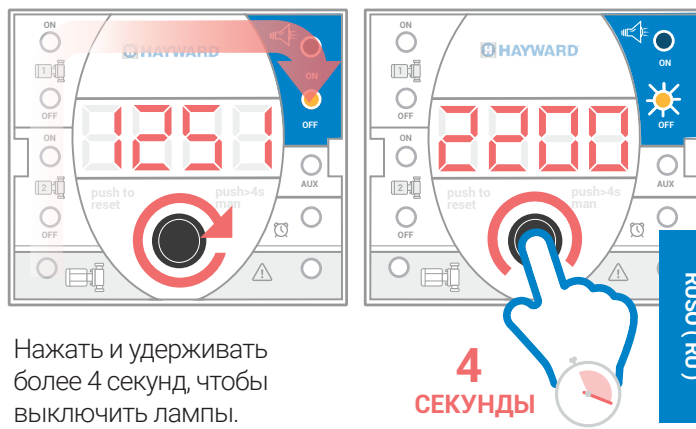

Нажать и удерживать более 4 секунд, чтобы выключить лампы.

Включаются в начале следующей программы освещения.

RUSO (RU)

6. Защита очистной установки

Калибровка защиты насоса

При первом запуске оборудование производит автоматическую настройку. Если вы желаете произвести новую автоматическую калибровку, выполните следующие шаги:

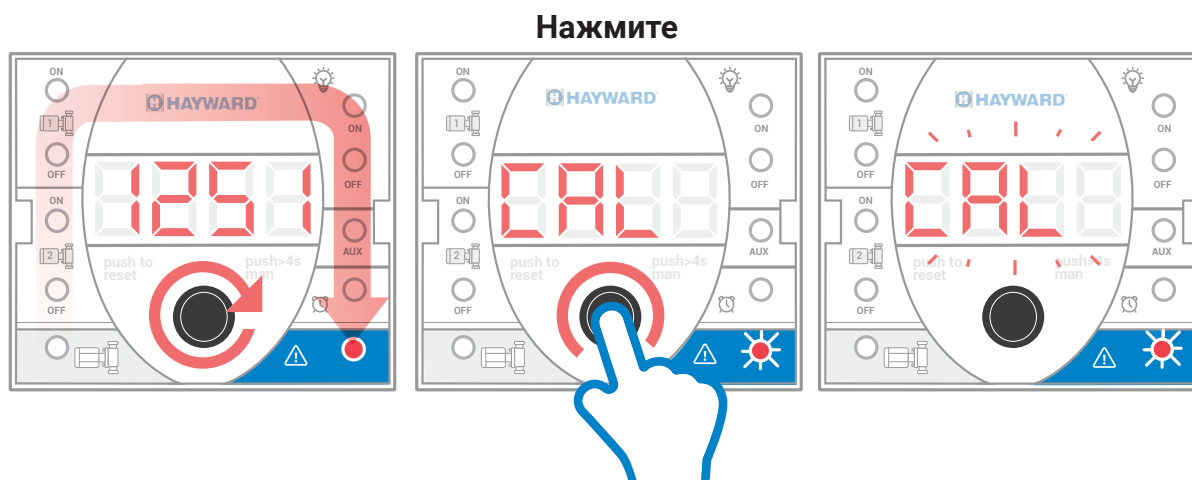

После того как будет подтверждена функция калибровки, насос произведет автоматическую настройку в течение первых 8 минут работы.

Чрезмерная нагрузка и перезапуск

Возможные причины:

- Насос не откалиброван.
- Насос заблокирован.



В случае чрезмерной нагрузки оборудование произведет до 3 попыток запуска с интервалом в 60 секунд



**Насос
ПЕРЕГРУЖЕН
 + 120%**

Система профилактики блокировки ротора (антиблокировочная защита)

Каждые 23 часа HPOWER приводит в действие очистную установку на 1 секунду, избегая блокировки ее двигателя. Это позволяет избежать возможных сбоев после длительных периодов простоя.

7. Дополнительные элементы управления

Очистная установка

▶ ЗАПУСК

При закрытии контакта производится запуск очистной установки.

⏸ ОСТАНОВКА

При открытии контакта производится пауза в работе очистной установки.

Освещение

ВКЛ

При закрытии контакта лампы включаются.

ВЫКЛ

При открытии контакта лампы выключаются.

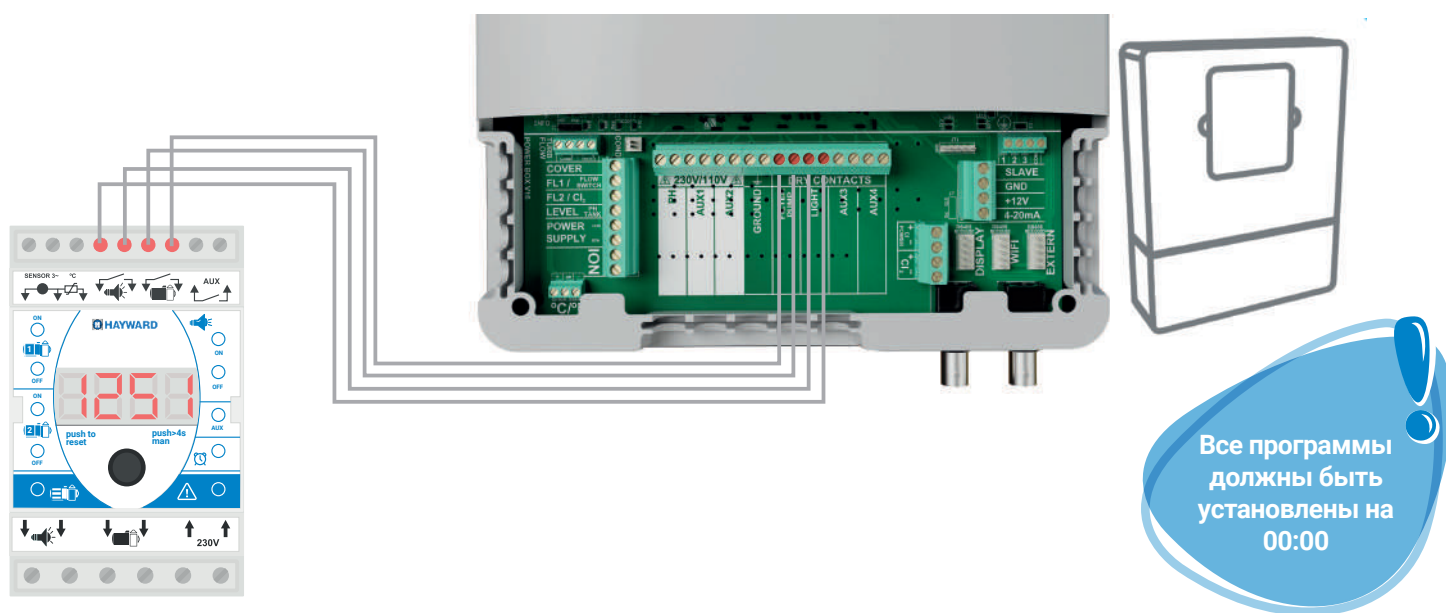

Температурный контроль

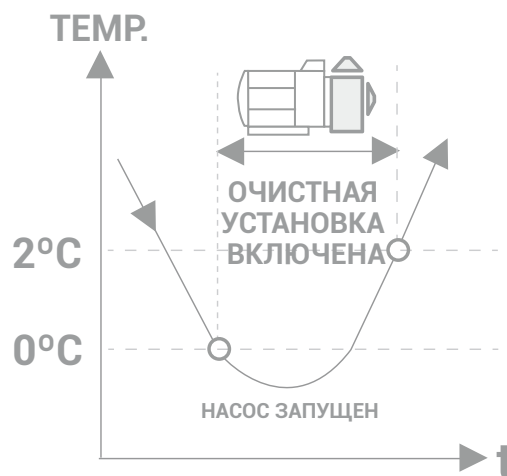
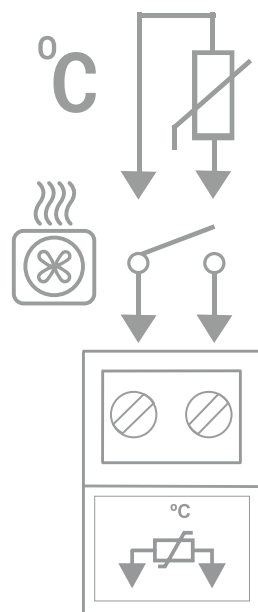
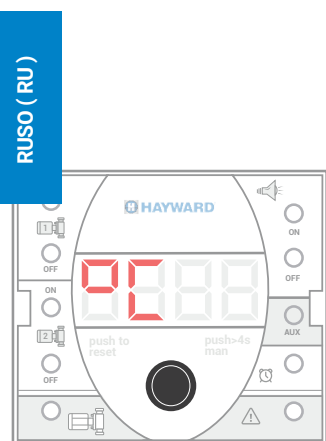

Контакт теплового насоса. **Когда он активируется**, на экране появляется символ «°C».

Наружный зонд температуры окружающей среды (**противообледенительный**). **Запускает очистную установку при очень низкой температуре окружающей среды.**

○ Вспомогательный контакт

Контакт **вспомогательного реле (AUX)** имеет нулево напряжение и **активируется одновременно с очистным насосом.**

Может использоваться последовательно с питанием насосов-дозаторов, солевых хлораторов или любого оборудования (**250В / 5А как максимум**), которое должно работать одновременно с очистным насосом.



8. Считывание данных

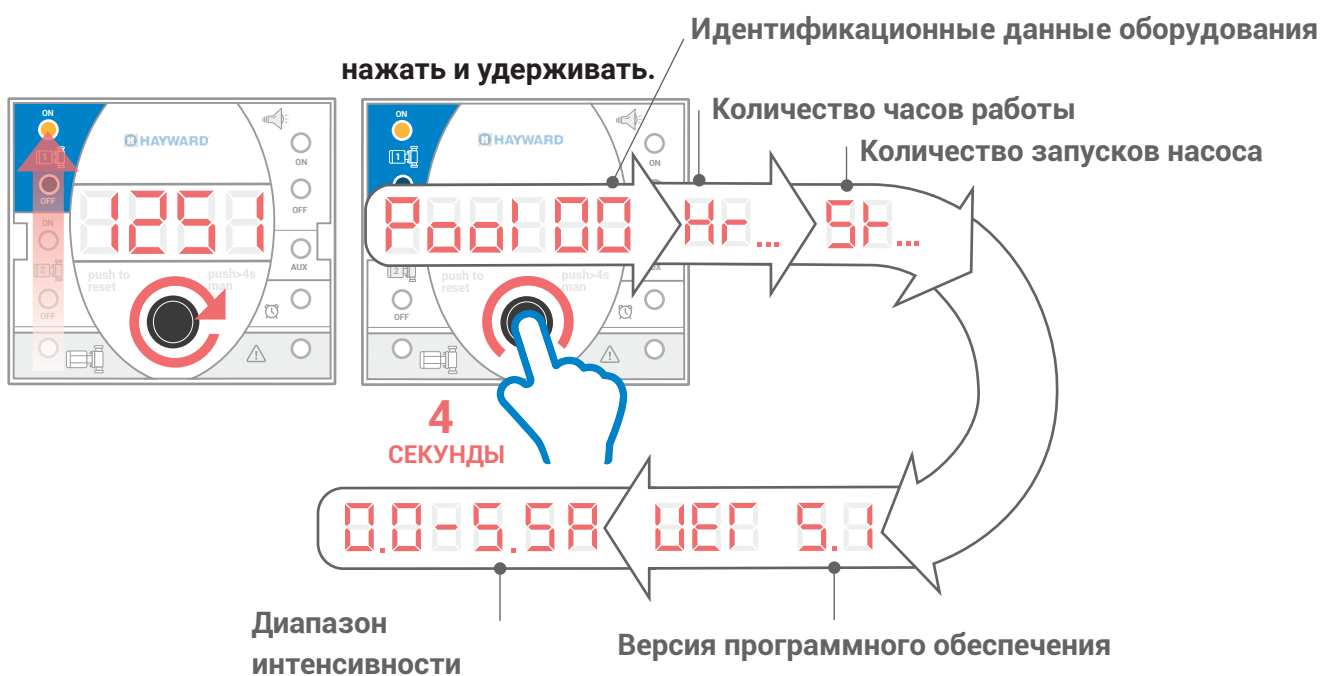

9. Bluetooth (только модель - B)

- 1. Скачать приложение HAYWARDPOWER.

Приложение для android



Приложение для iOS



- 2. Открыть приложение и СОЗДАТЬ ПАРУ с устройством

- 3. Интерфейс приложения.

Только для моделей Bluetooth H-POWER-B

Нажать

Запуск по температуре

Создать пару по Bluetooth

Тревожный сигнал очистной установки / перезапуск

Управление очистной установкой с помощью программы

Управление очистной установкой с помощью программы

Изменение цвета освещения

Ручное управление очистной установкой

Ручное управление освещением

Программирование

Очистная установка

Программа 1

Программа 2

Освещение

Программа

RUSO (RU)

10. Спецификации

Питание	230VAC / 400VAC - 50/60Hz
Выход насоса	14A, 230VAC
Выход освещения (в зависимости от модели)	230VAC / 5A 12 VAC / 50W 12VAC / 100W 12VAC / 300W
Сигнальная система	Запущенный насос, Тревожный сигнал, Программы фильтрации,
Защита	Перегрузка двигателя, Антиблокировка
Защита от перегрузки	20% сверх измеренной интенсивности калибровки
4-цифровой светодиодный дисплей	Текущее время, настройки и тревожные сигналы
Вспомогательное реле	Контакт с нулевым напряжением 250V/5A максимально
Максимальный отсек клемм	4 мм ² (потенциально) / 2,5 мм ² (управление)
IP/Температура	IP65/-10°...+55° C
Программное обеспечение	V.5
Директивы	- 2016 - D.C. 2014 / 30 / CE EMC D.C. 2014 / 35 / UE C.E. ROHS EN61558 Трансформатор ламп.
Опции	Интерфейс Bluetooth (-B) Дифференциал (-D) Трансформатор 50W (T50) Трансформатор 100W (T100) Трансформатор 300W (T300) Дистанционное радиоуправление Наружный зонд температуры окружающей среды

Данные

НР0W230BDT50



RUSO (RU)





HAYWARD POOL EUROPE S.A.
Pol. Ind. PLAINE DE L'AIN ALLE DES CHENES
SAINT VULBAS, 01150
FRANCE
Phone: +33 474462470



EU DECLARATION OF CONFORMITY

This declaration of conformity is issued under the sole responsibility of the manufacturer, it is carried out based on the tests carried out under the tutelage of the regulatory agency designated by the manufacturer.

Product Description: DIGITAL CONTROL PANEL

Product reference:

HPOW230B -- HPOW230BD -- HPOW230BDT100 -- HPOW230BDT300 -- HPOW230BDT50
HPOW230BT100 -- HPOW230BT300 -- HPOW230BT50 -- HPOW400BDT100 -- HPOW400BDT50

- **Declaration of Conformity L.V.D - Low voltage according to Directive LVD 2014/35/EU**

Harmonized regulations: EN 60529:1991 + AC:1993 + A1:2000 + A2:2013 + AC:2016-12 + A2:2013/AC:2019-02
Test number: SAFETOSCA210101 & 03SAFETOSCA210102-00

- **Declaration of conformity C.E.M - Electromagnetic compatibility according to ECM Directive 2014/30/EU**

Harmonized standard: IEC 61326-1:2020 + EN 62479:2010
Test number: 03EMCOTOSCA210101-00 & 03EMFITOSCA210101-00

- **Directive 2014/53/EU – RED, RADIO EQUIPMENT**

Harmonized standard: ETSI EN 300 328-1 V2.2.2 Article 3.2 Directive 2014/53/EU – RED EN 61010-1:2010+A1:2019 EN 62479:2010 Article 3.1a
Directive 2014/53/EU – RED EN IEC 61326-1:2021 ETSI EN 301 489-1 V2.2.3 ETSI EN 301 489-17 V3.2.4 Article 3.1b Directive 2014/53/EU - RED
Test number: 03EMCOTOSCA210102-00

- **RoHS Declaration of Conformity under Directive on the Restriction of the Use of Certain Hazardous Substances in Electrical and Electronic Equipment (RoHS) 2011/65/EU and Delegated Directive (EU)2015/863**

- **Declaration of conformity Ecodesign according to Directive 2009/125/EC**

We certify the conformity of products with the corresponding standards, listed in this declaration, provided that their installation and use comply with the prescribed standards.

Place, date: Yuncos, 10/10/2022

Authorized signature:

Ivan Mata Soria
Quality Manager Europa



Hayward is a registered trademark
of Hayward Industries, Inc.
© 2018 Hayward Industries, Inc.