

*NEVIS*  
*ART.NR. 445193*  
*1/8*

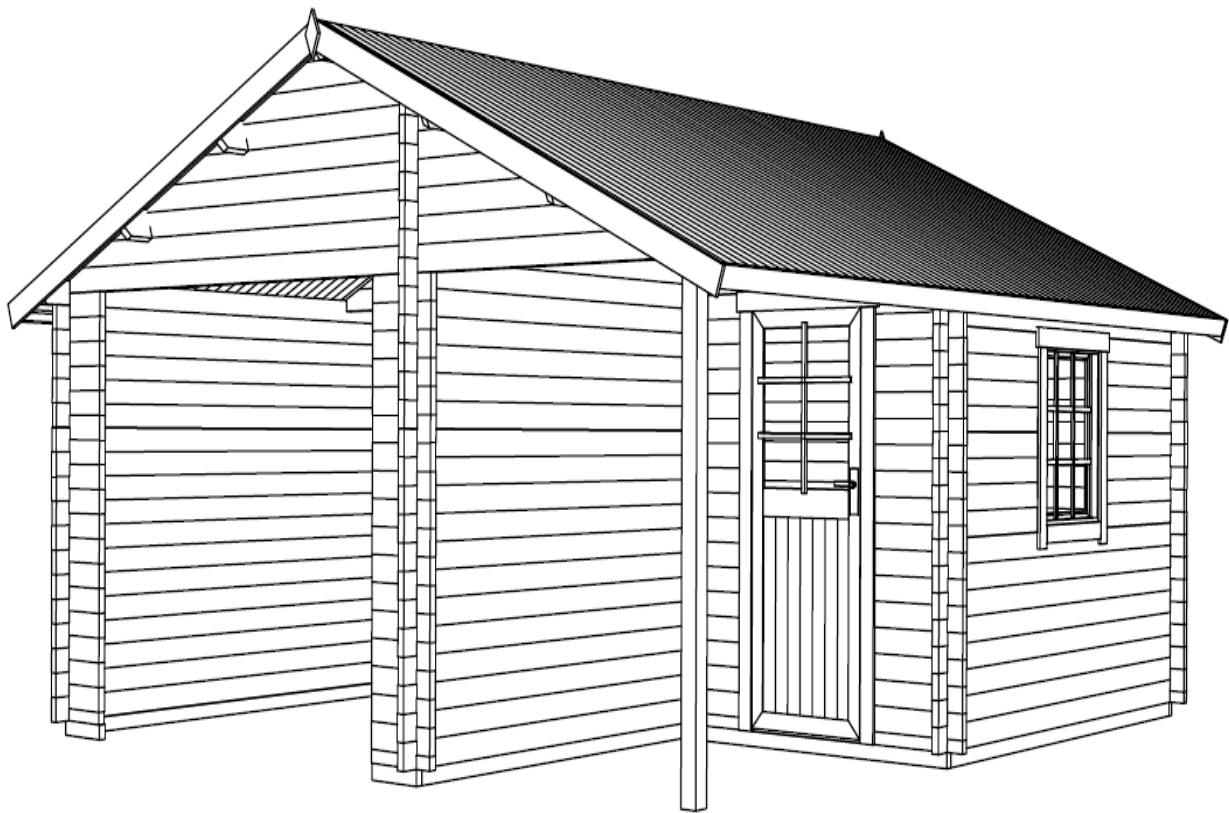

GROUNDPLAN - GRUNDPLAN - PLAN DE MASSE

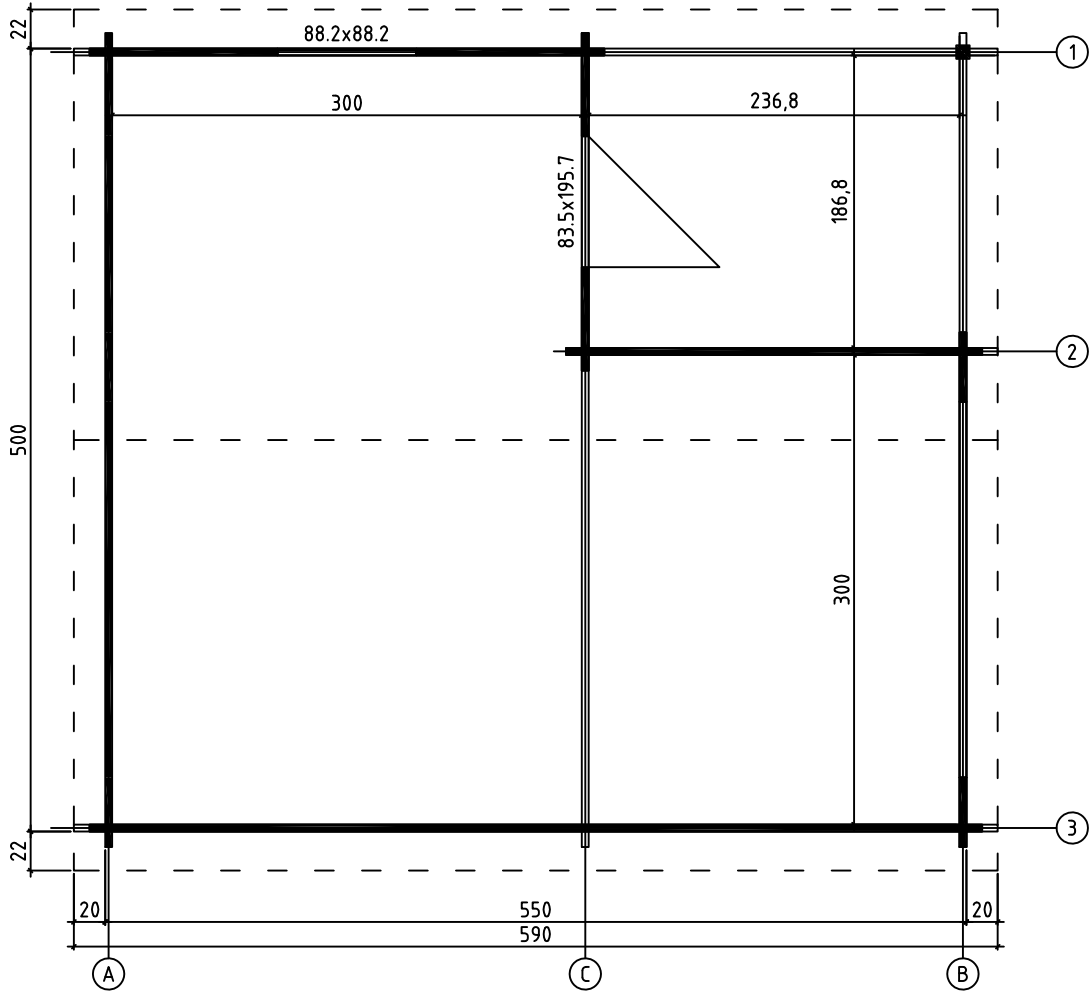

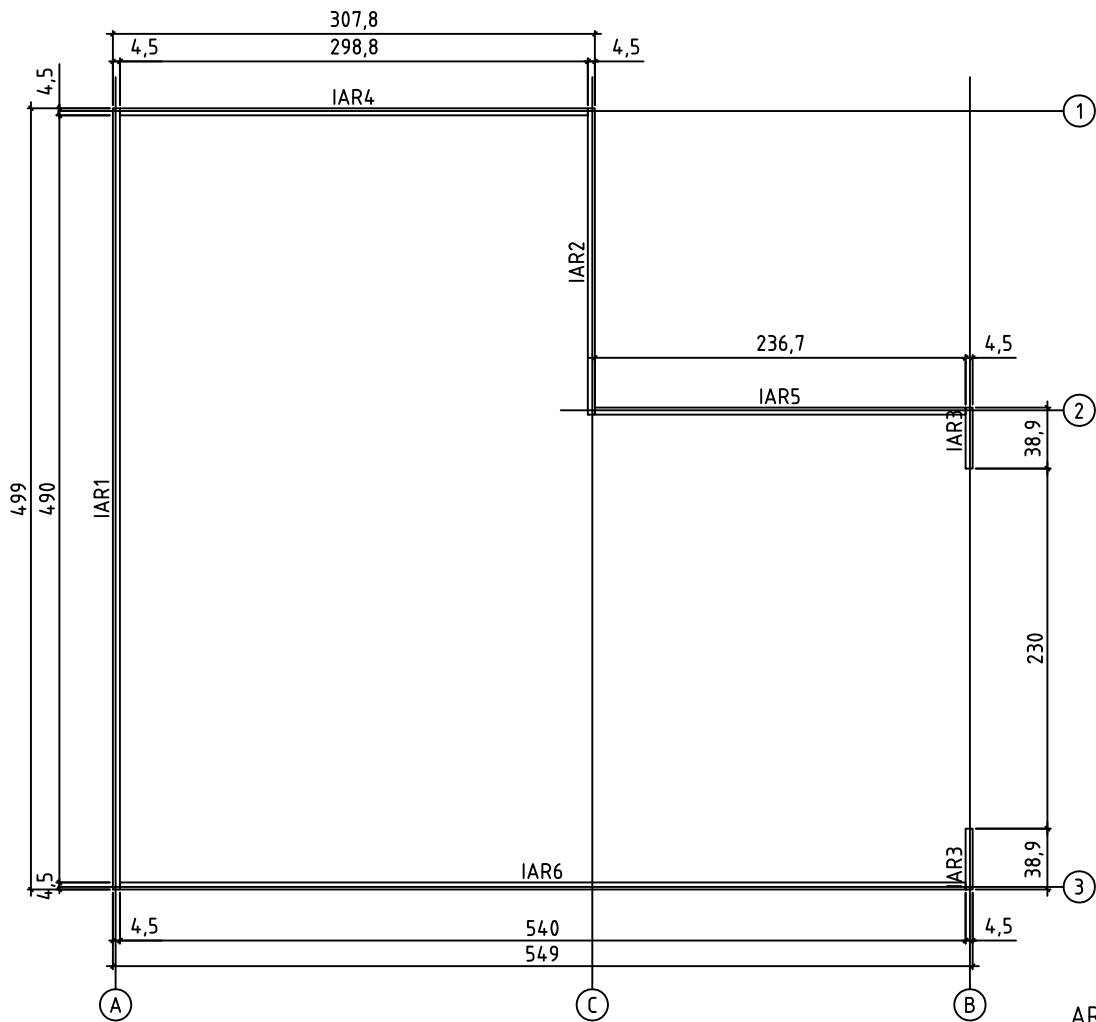

FOUNDATION - FUNDAMENT - FONDATION

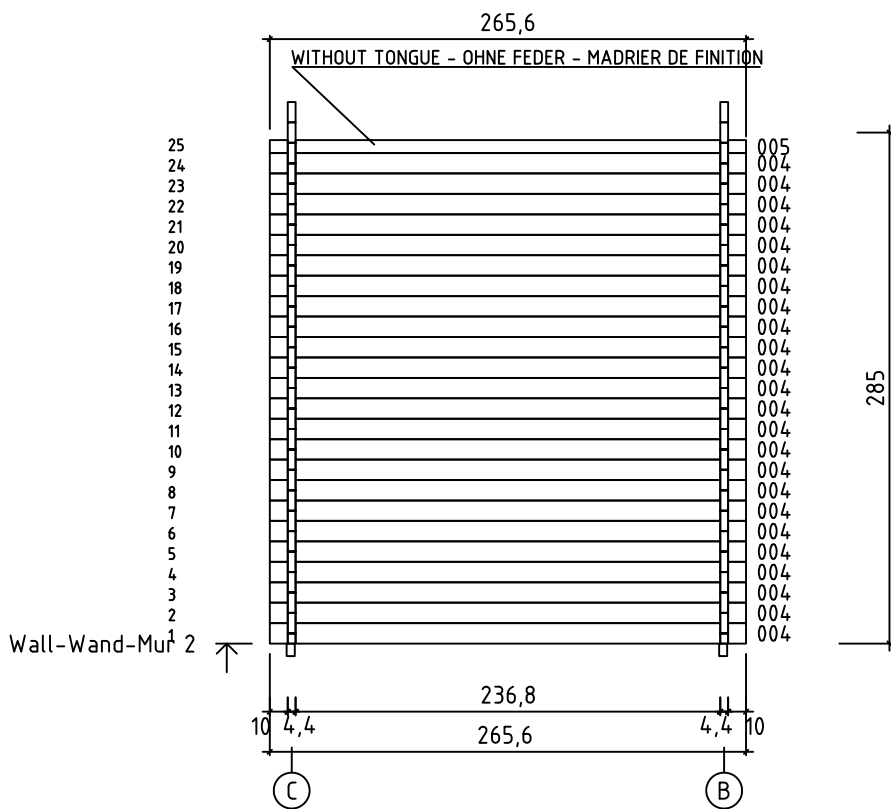
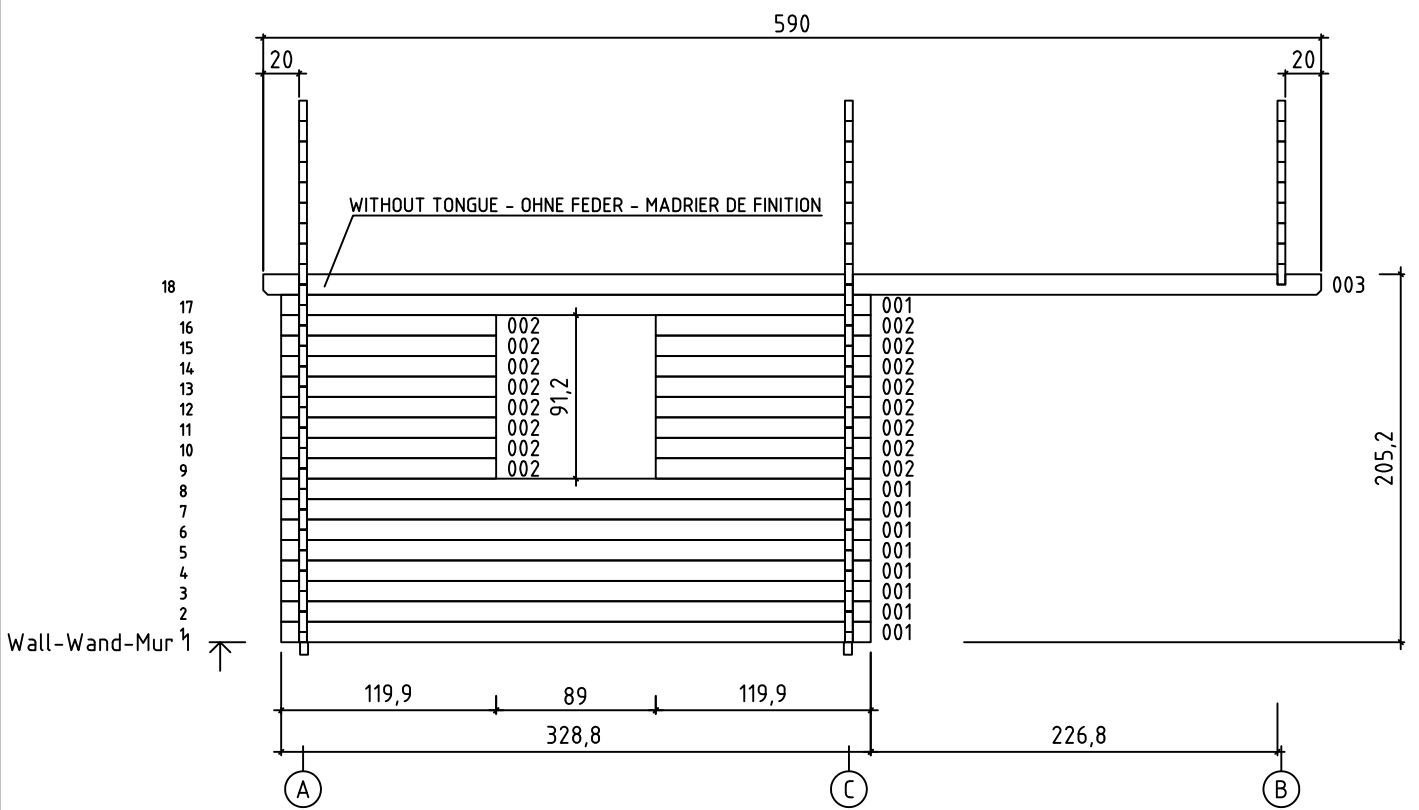

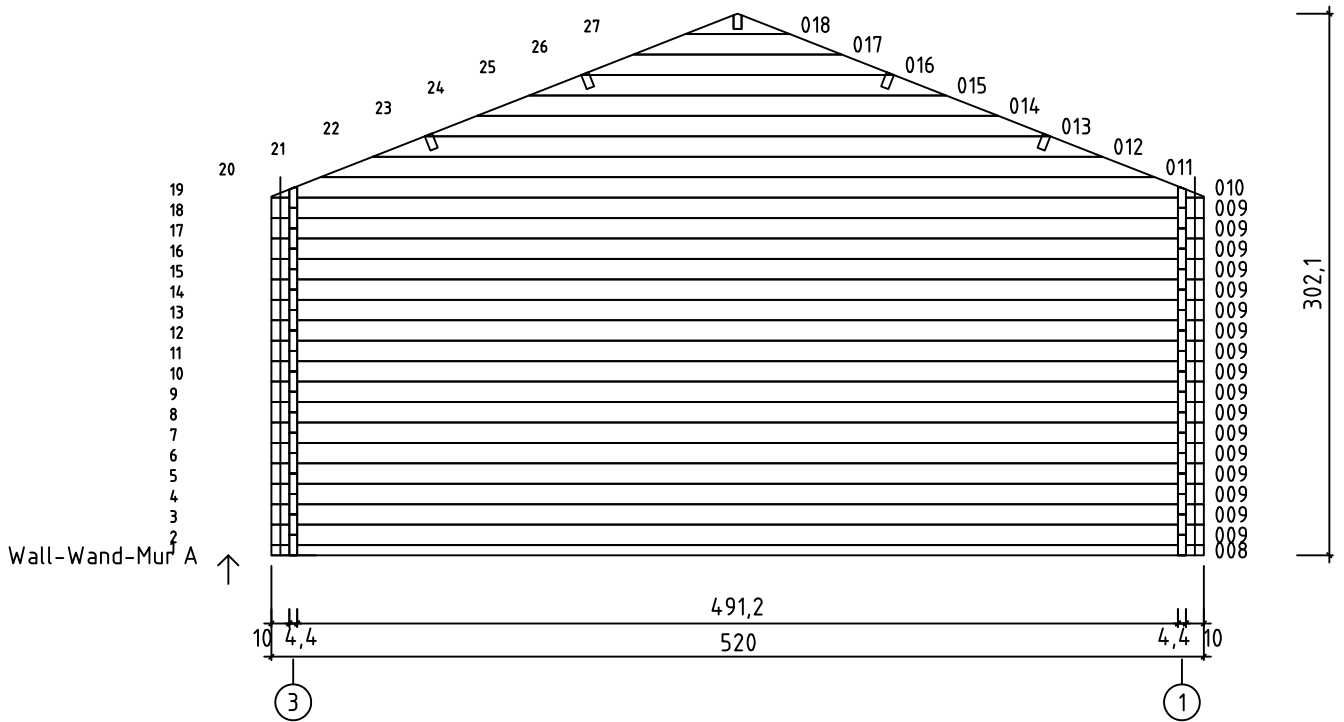
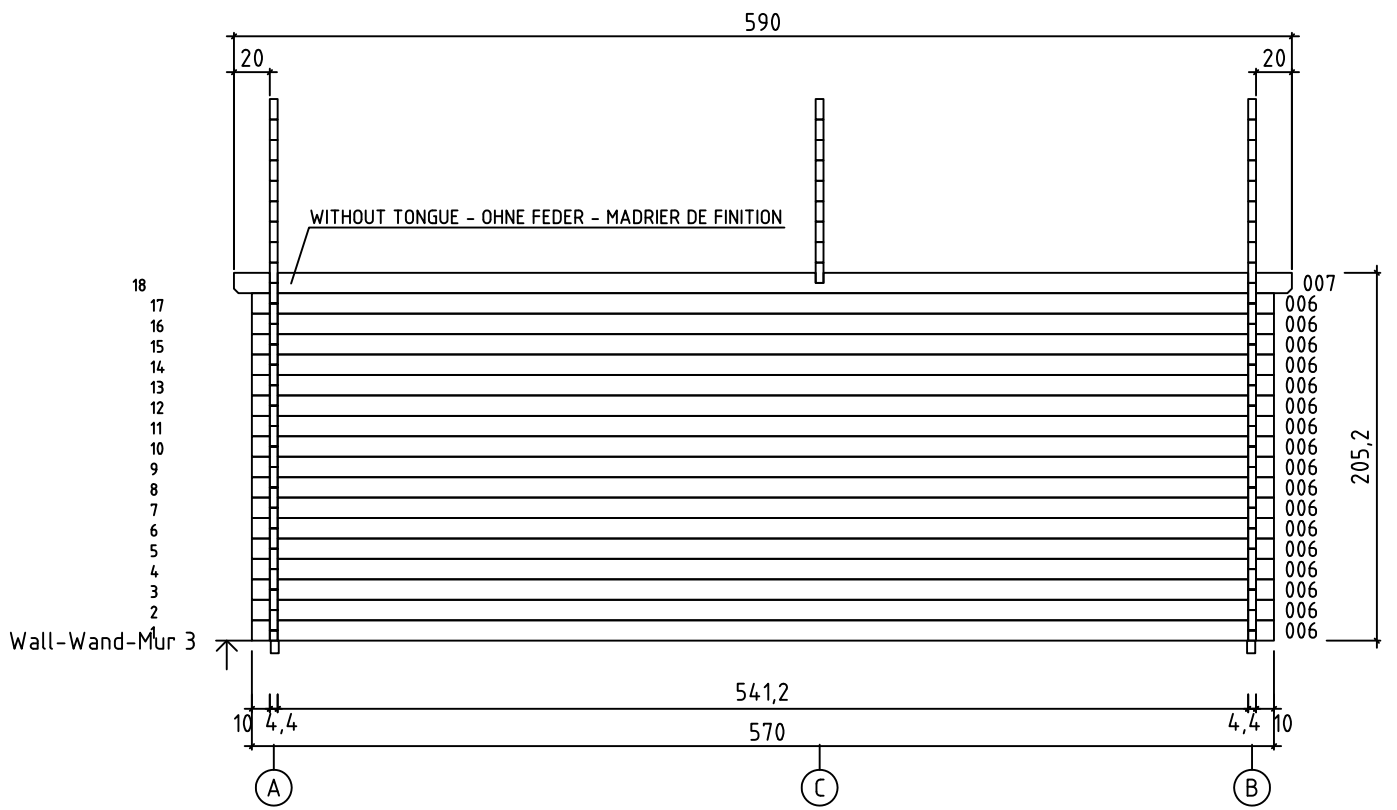

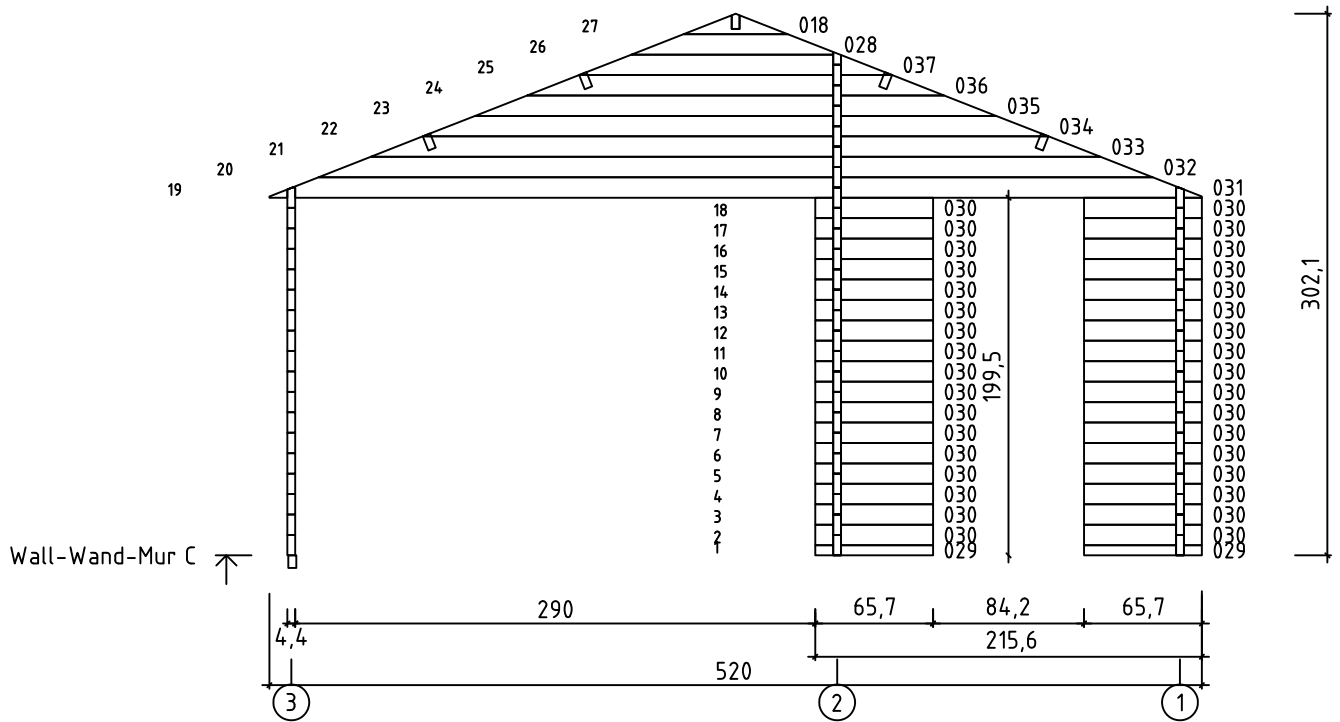
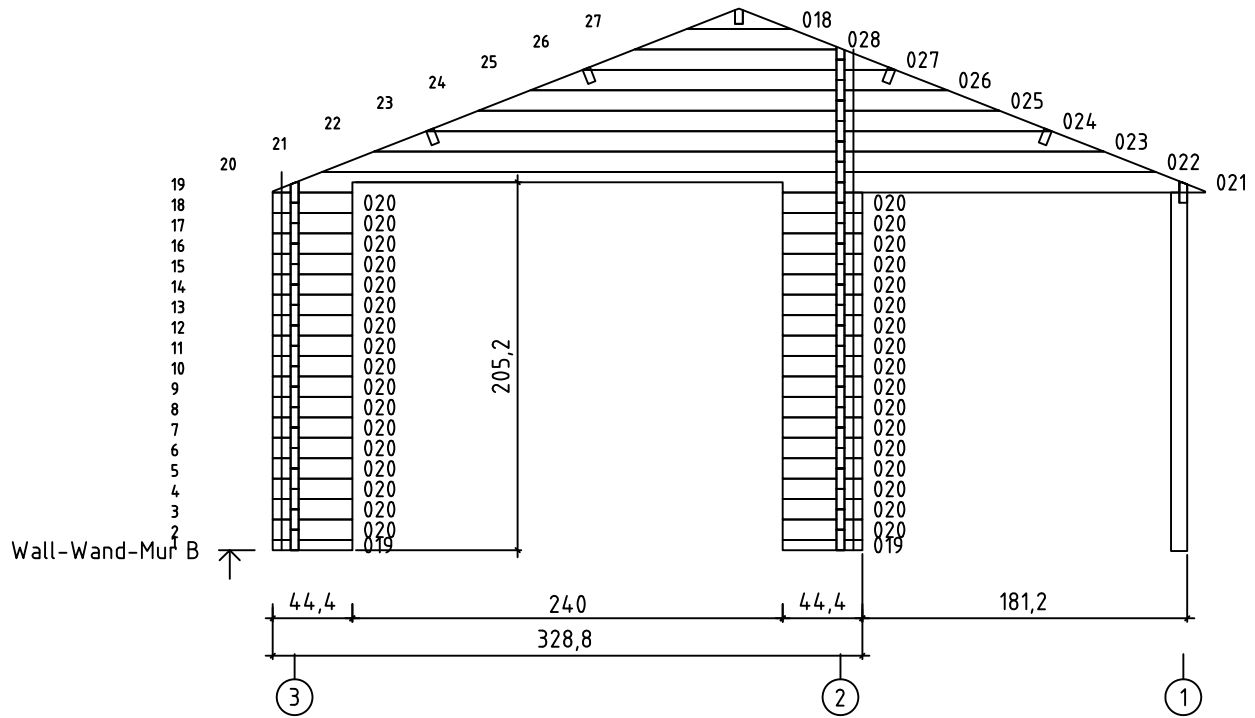

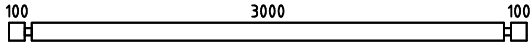
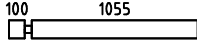
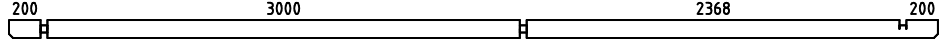
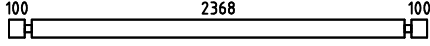
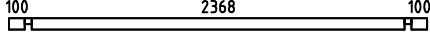
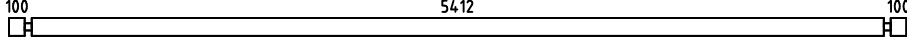
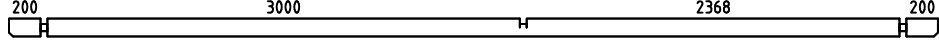
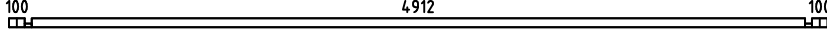
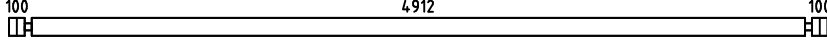

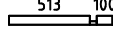
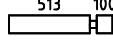
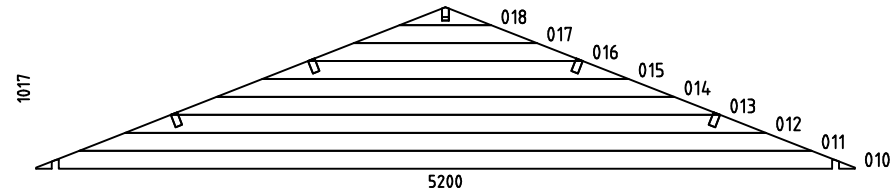
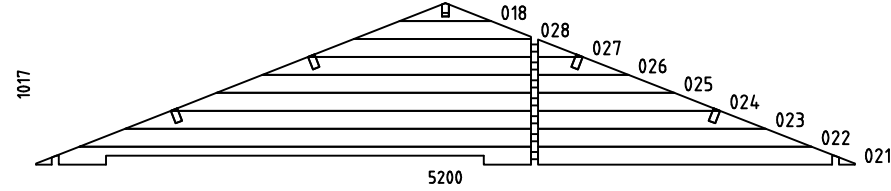
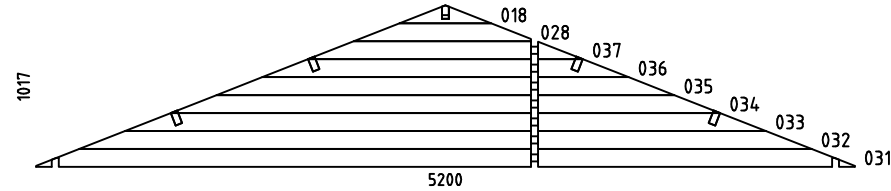
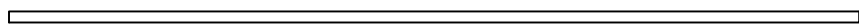
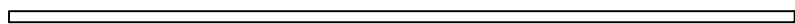

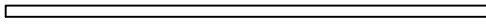
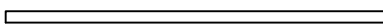
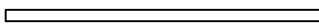

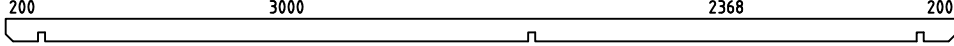



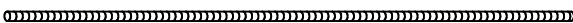
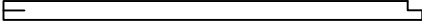
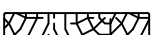

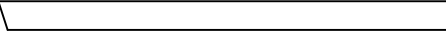







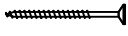



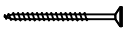
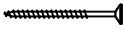
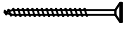
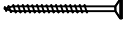
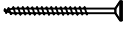

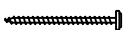
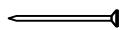
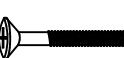

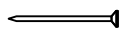
Pos	22.08.2013	ART.NR. 445193	6/8	Q.	P (mm)	L (mm)
001				9	44x114	3288
002				16	44x114	1199
003				1	44x120	5900
004				24	44x114	2656
005				1	44x72	2656
006				17	44x114	5700
007				1	44x120	5900
008				1	44x57	5200
009				17	44x114	5200
019				2	44x57	444
020				34	44x114	444
029				2	44x57	657
030				34	44x114	657
WA-1				1		
WB-1				1		
WC-1				1		
IAR6	FOUNDATION - FUNDAMENT - FONDATION					
IAR6				1	45x70	5400
IAR1	FOUNDATION - FUNDAMENT - FONDATION					
IAR1				1	45x70	4990

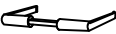
Pos	22.08.2013	ART.NR. 445193	7/8	Q.	P (mm)	L (mm)
IAR4	FOUNDATION - FUNDAMENT - FONDATION 			1	45x70	2988
IAR5	FOUNDATION - FUNDAMENT - FONDATION 			1	45x70	2367
IAR2	FOUNDATION - FUNDAMENT - FONDATION 			1	45x70	1957
IAR3	FOUNDATION - FUNDAMENT - FONDATION 			2	45x70	389
PR11	ROOF BEAM - DACHBALKEN - PANNE DE TOIT 			1	44x140	5900
PR21	ROOF BEAM - DACHBALKEN - PANNE DE TOIT 			4	44x140	5900
	ROOF BOARDS - DACHBRETTER - VOLIGES 			132	90x18	2900
	ROOFING FELT FILLET - DACHPAPPENLEISTE - BAGUETTE DE FIXATION DU FEUTRE BITUMEUX 			4	18x58	2950
	TREADED ROD M10 - GEWINDESTANGE M10 - TIGE FILETÉE M10 			3		50
	TREADED ROD M10 - GEWINDESTANGE M10 - TIGE FILETÉE M10 			1		800
	TREADED ROD M10 - GEWINDE-STANGE M10 - TIGE FILETÉE M10 			4		2000
	POST - PFOSTEN - POTEAU 			1	90x90	1985
	EAVES BOARD - TRAUFBRETT - BANDEAU DE TOIT 			4	18x90	2950
	ROOF EDGE REINFORCEMENT - DACHRANDVERSTÄRKUNG - CORNIERE DE RENFORT DE BORD DE TOIT 			4	28x34	2950
	GABLE MOULDING - GIEBELLEISTE PLANCHE DE RIVE 			4	18x120	2950
	WINDOW HANDLE FITTINGS-FENSTERGRIFF - POIGNÉE D'OUVERTURE DE FENETRE 			1		
	LENGTHENING BOLT FOR TREADED ROD -VERLÄNGERUNGSMUTTER FÜR GEWINDESTANGE -MANCHON DE RACCORDEMENT DE TIGE FILETÉE 			4		
	DRIVE NUT TREADED ROD - EINSHLAGMUTTER FÜR GEWINDESTANGE - ÉCROU A FRAPPER POUR TIGE FILITÉE 			4		
	NUT FOR TREADED ROD - MUTTER FÜR GEWINDESTANGE - ÉCROU POUR TIGE FILETÉE 			4		
	PLAIN WASHER TREADED ROD - UNTERLEGSSCHEIBE FÜR GEWINDESTANGE - RONDELLE PLATE POUR TIGE FILETÉE 			4		
	SCREW FOR GABLE SEGMENT - SCHRAUBEN FÜR DECKBLATT - VIS POUR FIXATION LOSANGE DE FINITION 			4	3.5x35	
	SCREW FOR GABLE MOULDING - SCHRAUBEN FÜR GIEBELLEISTE - VIS DE FIXATION POUR PLANCHE DE RIVE 			32	3.5x50	
	SCREW FOR POST - SCHRAUBEN FÜR PFOSTEN - VIS DE FIXATION DES POTEAUX 			2	4.5x80	
	SCREW FOR EAVES BOARDS - SCHRAUBEN FÜR TRAUFBRETTER - VIS DE FIXATION POUR BANDEAU DE TOIT 			28	4x40	

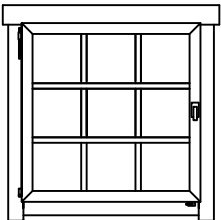
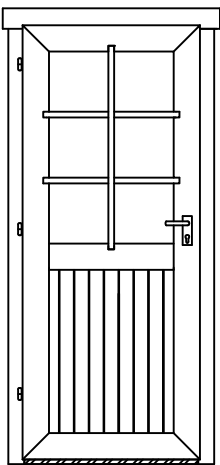
Pos	22.08.2013	ART.NR. 445193	8/8	Q.	P (mm)	L (mm)
	SCREW FOR ROOF EDGE REINFORCEMENT - SCHRAUBEN FÜR DACHRANDVERSTÄRKUNG - VIS POUR RENFORT DE BORD DE TOIT			28	4x40	
	SCREW FOR ROOF BEAMS - SCHRAUBEN FÜR DACHBALKEN - VIS POUR PANNE DE TOIT			21	5x120	
	SCREW FOR GABLE - SCHRAUBEN FÜR GIEBEL - VIS POUR FIXATION DES PIGNONS			54	5x120	
	SCREW FOR 1. WALL BEAM - SCHRAUBE FÜR 1. BOHLENREIHE - VIS DE FIXATION DES FONDATIONS			12	5x90	
	SCREW FOR FUNDAMENT - SCHRAUBEN ZUR BEFESTIGUNG FUNDAMENT - VIS POUR FONDATION			12	5x90	
	SCREW FOR POST HEIGHT ADJUSTMENT - SCHRAUBEN FÜR REGULIERUNGSSCHRAUBE FÜR PFOSTEN - VIS DE FIXATION DE SUPPORT RÉGLABLE DE POTEAU			8	6x50	
	HAMMER BLOCK - SCHLAGHOLZ - CALLE DE FRAPPE			1		
	SCREW FOR DOORSTEP - SCHRAUBEN FÜR SWELLE - VIS DE FIXATION DU SEUIL DE PORTE			2	4.5x65	
	ZN NAIL FOR ROOFING FELT FILLET - ZN NÄGEL FÜR DACHPAPPENLEISTE - POINTE POUR BAGUETTE FIXATION FEUTRE BITUMEUX			28	2x40	
	BOLT FOR WINDOW HANDLE FITTINGS - BOLZEN FÜR FENSTERGRIFF BESCHLAG - BOULON POUR POIGNÉE D'OUVERTURE DE FENETRE			2		
	GABLE SEGMENT-DECKBLATT - LOSANGE DE FINITION			2		
	ZN NAIL FOR ROOF - ZN NÄGEL FÜR DACHBRETTER - POINTE POUR TOIT			554	2x50	
	SET OF DOOR LOCK COVERS - SCHLOSSBLENDEN - SET DE GARNITURES DE SERRURE DE PORTE			1		
	DOOR HANDLE FITTINGS-TÜRGRIFF - SET DE GARNITURES DE SERRURE DE PORTE			1		
	POST HEIGHT ADJUSTMENT - REGULIERUNGSSCHRAUBE FÜR PFOSTEN - SUPPORT RÉGLABLE DE POTEAU			1		
	CYLINDER - ZYLINDERSCHLOSS - CYLINDRE DE SERRURE			1		
	SCREW FOR GEORGIAN BARS - SCHRAUBE FÜR SPROSSEN - VIS DE BARRES GEORGIANNE			14		
	WINDOW-FENSTER-FENETRE 882x882		AK.1.109.SSV.b	1		
	DOOR-TÜR-PORTE 835x1957		UK.2.056.SVV.MM	1		